

ORBITA™ I PENDANT

PROJECT: _____

TYPE: _____

QUANTITY: _____



PN: 9910RI

ILLUMINATION	<ul style="list-style-type: none"> • 7196 - 17648 LUMENS • DIRECT OR INDIRECT/DIRECT • LED 90CRI
APPLICATION	<ul style="list-style-type: none"> • DIRECT OR DIRECT/INDIRECT PENDANT MOUNT • INDOOR RATED
DIMENSION	<ul style="list-style-type: none"> • 36", 48", 60", 84" DIA. (91cm, 122cm, 152cm, and 213cm) • PROFILE: 1.68"W X 2.73"H (4.2cm X 6.93cm)
ELECTRICAL	<ul style="list-style-type: none"> • 120 - 277V • 10KV SURGE SUPPRESSION
DIFFUSERS	<ul style="list-style-type: none"> • HIGH EFFICIENCY ACRYLIC
MOUNTING	<ul style="list-style-type: none"> • 120" POWER OVER SUSPENSION • 120" (305cm) BLACK OR WHITE DROP CORD WITH AC CABLES
LED DRIVER	<ul style="list-style-type: none"> • CANOPY OR REMOTE MOUNT
CONSTRUCTION	<ul style="list-style-type: none"> • ALUMINUM
FINISHES	<ul style="list-style-type: none"> • AVAILABLE IN SEVERAL TMS POWDER COATED FINISHES • CUSTOM RAL FINISHES AVAILABLE
DIMMING	<ul style="list-style-type: none"> • 0 - 10V DIMMING (120-277V) • LINE VOLTAGE/TRIAC/ELV (120V ONLY) • LUTRON DIMMING (120-277V)
WEIGHT	<ul style="list-style-type: none"> • 20 LBS MINIMUM, 40 LBS MAXIMUM

CROSS SECTION

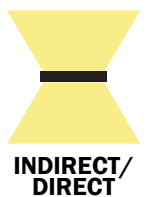
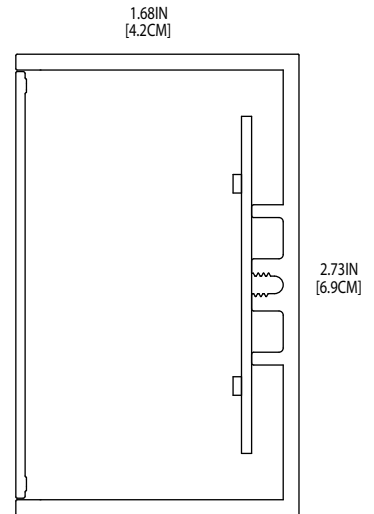

ORBITA™ I PENDANT

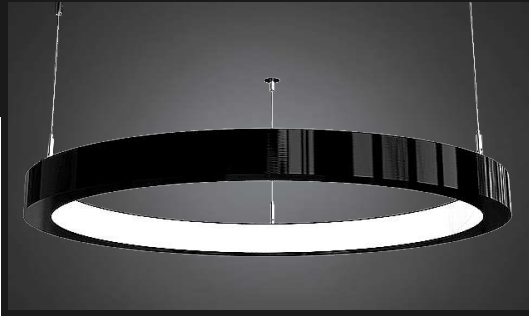

PROJECT: _____

TYPE: _____

QUANTITY: _____

9910RI

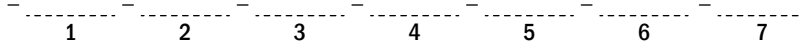

1.	36	48	60	72	84
DIA (INCH)	36"	48"	60"	72"	84"
LED (W)	74	99	125	150	175
LUMEN	7196	9866	12490	15133	17648

2.	H	M	L	C: _____
OUTPUT	100% LUMENS	75% LUMENS	50% LUMENS	[CUSTOM]% LUMENS

3.	30K	35K	40K
CCT	3000	3500	4000

4.	MMCD	MMRM	PSCD	PSRM
MOUNTING	MULTIPLE CABLES WITH CANOPY DRIVER	MULTIPLE CABLES WITH REMOTE DRIVER	SINGLE POINT WITH CANOPY DRIVER	SINGLE POINT WITH REMOTE DRIVER

5.	BC	WC	POS
CORD	BLACK DROP CORD WITH AIRCRAFT CABLES	WHITE DROP CORD WITH AIRCRAFT CABLES	POWER OVER SUSPENSION (SILVER ONLY) (UP TO 60" DIA.) (NOT APPLICABLE FOR MMCD COMBINATION)

6.	ADDITIONAL AND PREMIUM FINISHES AVAILABLE. SEE FINISHES CHART							
FINISH	F04	F05	F15	F16	F09	F31	F18	
	MATTE WHITE	GLOSS WHITE	MATTE BLACK	GLOSS BLACK	PEWTER	SILVER METALLIC	SATIN ALUMINUM	

7.	DIML	DIME	DIMV
DIMMING	0-10V (120-277V)	LUTRON HI-LUME (120-277V) (UP TO 60" ONLY)	LINE VOLTAGE/TRIAC/ELV (120V ONLY)

NOTE: SOME OPTIONS MAY NOT BE COMPATIBLE WITH OTHERS. ALL SPECIFICATIONS ARE SUBJECT TO CHANGE WITHOUT NOTICE. CONTACT TMS LIGHTING FOR UPDATED SPECIFICATIONS.

ORBITA™ I PENDANT

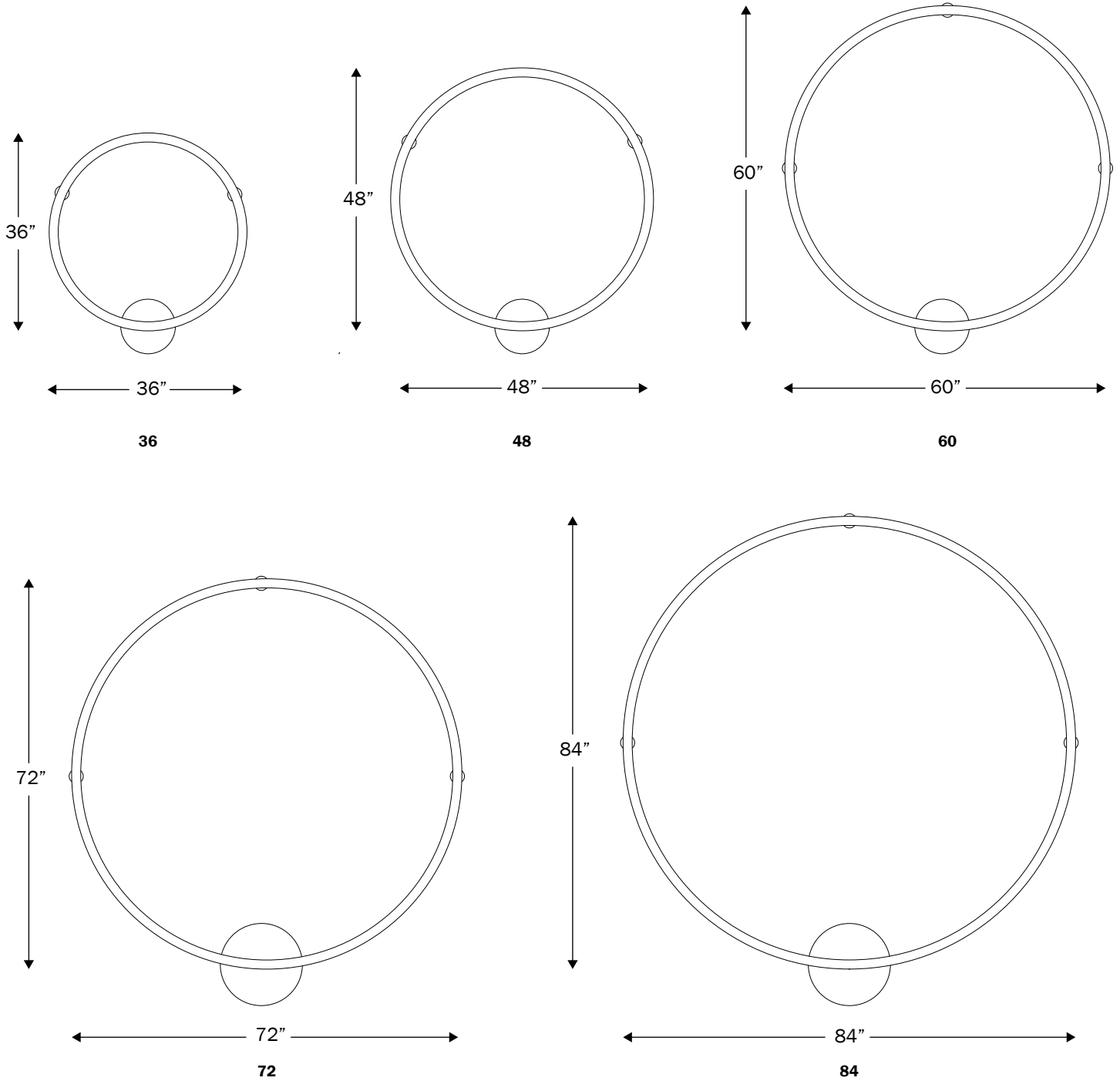

SIZES	DIAMETER	MOUNTING POINT	MINIMUM DISTANCE ^{1,2}	CANOPY SIZE		NUMBER OF CANOPY	WEIGHT (POUNDS - LBS)	SECTIONS
				MMCD	PSCD - PSRM			
36	36.5"	3	42"	10"	10"	1	20	1
48	47.5"	3	54"	10"	10"	1	25	1
60	59.5"	3	66"	10"	10"	1	30	1
72	72"	4	78"	15"	15"	1	35	1
84	84"	4	96"	15"	15"	1	40	1

1. ONLY FOR PS (SINGLE POINT) MOUNTING OPTION, THIS IS THE MINIMUM DISTANCE FROM CEILING TO THE BOTTOM OF THE FIXTURE
 2. MINIMUM CABLE MOUNTING ANGLE IS 70°

POS (POWER OVER SUSPENSION)

MMRM COMBINATION (MULTIPLE CABLES, REMOTE MOUNT DRIVER)

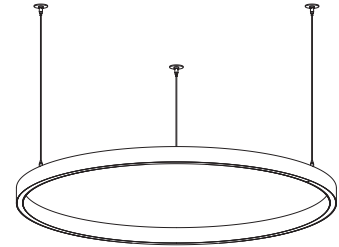
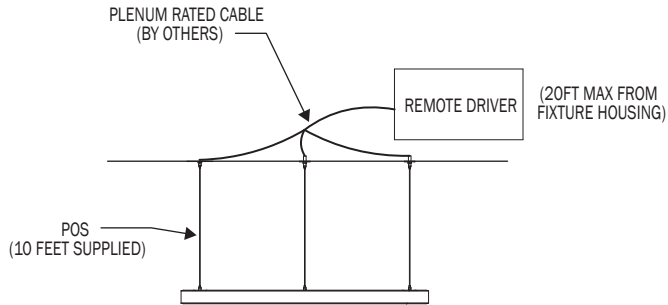

PSCD COMBINATION (SINGLE POINT, CANOPY MOUNT DRIVER)

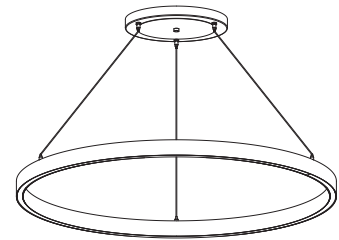
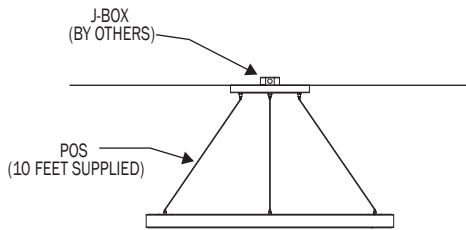

PSRM COMBINATION (SINGLE POINT, REMOTE MOUNT DRIVER)

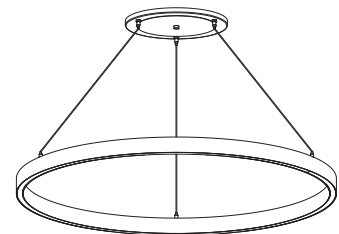
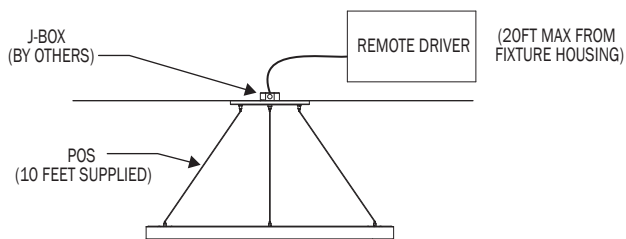

DROP CORD

MMCD COMBINATION (MUTIPLE CABLES, CANOPY MOUNT DRIVER)

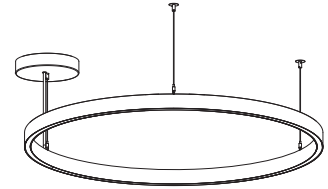
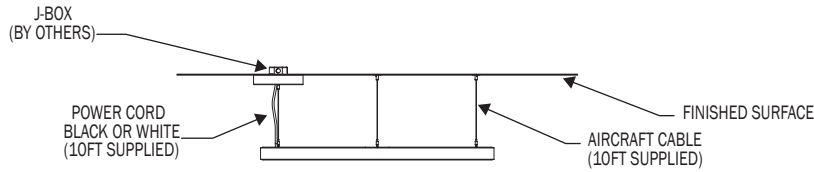

MMRM COMBINATION (MUTIPLE CABLES, REMOTE MOUNT DRIVER)

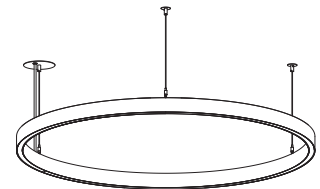
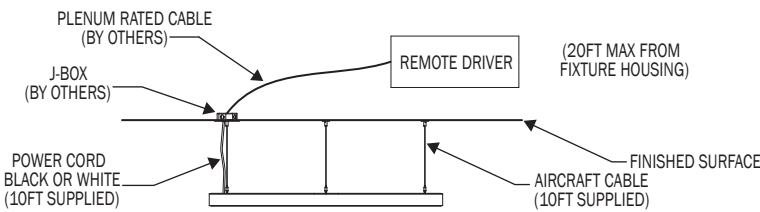

PSCD COMBINATION (SINGLE POINT, CANOPY MOUNT DRIVER)

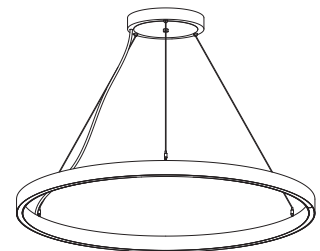
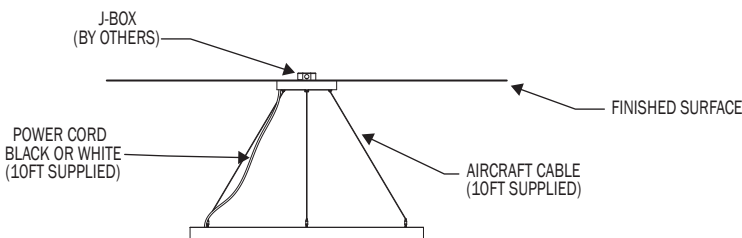

PSRM COMBINATION (SINGLE POINT, REMOTE MOUNT DRIVER)

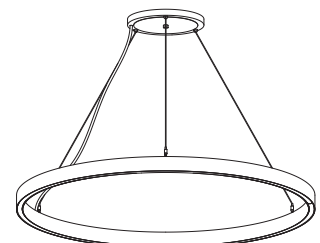
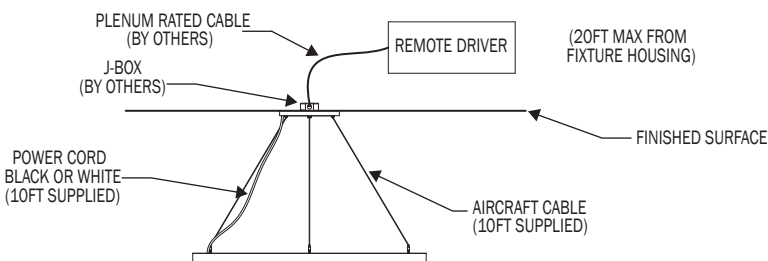

PN (INCH)	LUMENS	WATTAGE
36 (36")	7196	74
48 (48")	9866	99
60 (60")	12490	125
72 (72")	15133	150
84 (84")	17648	175

IES INDOOR REPORT
PHOTOMETRIC FILENAME : 9910RI 36 35K F05.IES

POLAR GRAPH

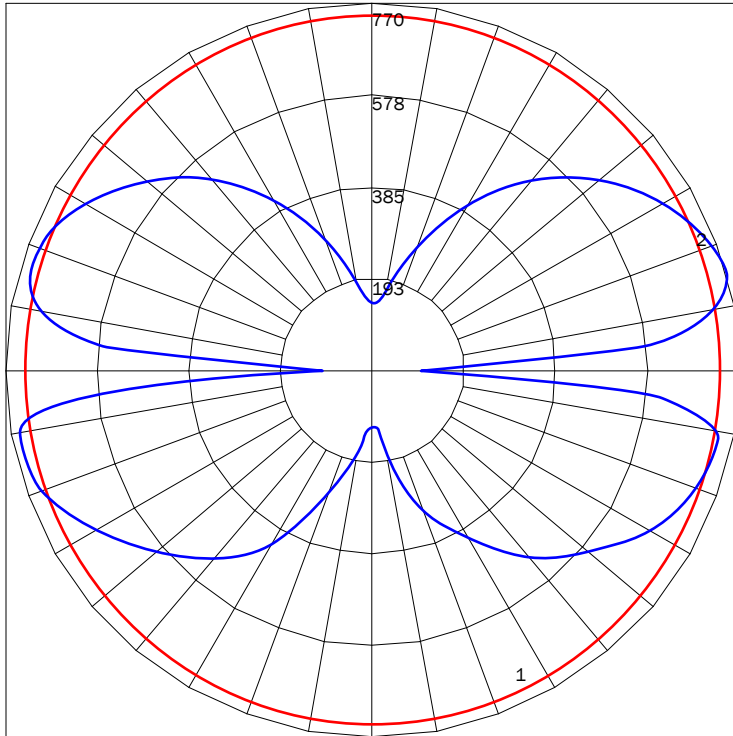

MAXIMUM CANDELA = 2962.16 LOCATED AT HORIZONTAL ANGLE = 157.5, VERTICAL ANGLE = 5
 # 1 - VERTICAL PLANE THROUGH HORIZONTAL ANGLES (157.5 - 337.5) (THROUGH MAX. CD.)
 # 2 - HORIZONTAL CONE THROUGH VERTICAL ANGLE (5) (THROUGH MAX. CD.)

LUMINAIRE LUMENS	7196
TOTAL LUMINAIRE EFFICIENCY	69%
LUMINAIRE EFFECIENCY RATING	97
TOTAL LUMINAIRE WATTS	74

IES INDOOR REPORT
PHOTOMETRIC FILENAME : 9910RI 84 35K F05.IES

POLAR GRAPH

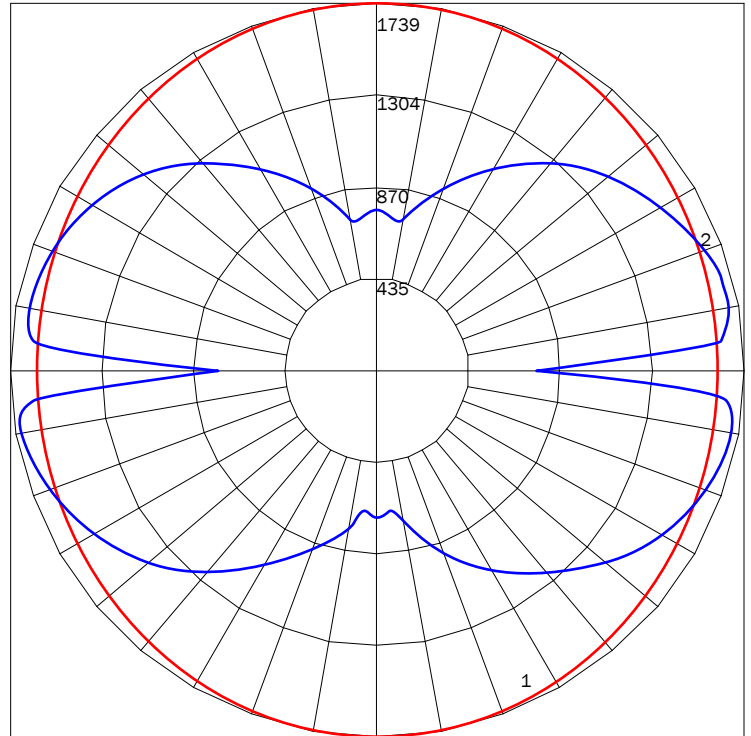

MAXIMUM CANDELA = 3017.67 LOCATED AT HORIZONTAL ANGLE = 0, VERTICAL ANGLE = 10
 # 1 - VERTICAL PLANE THROUGH HORIZONTAL ANGLES (0 - 180) (THROUGH MAX. CD.)
 # 2 - HORIZONTAL CONE THROUGH VERTICAL ANGLE (10) (THROUGH MAX. CD.)

LUMINAIRE LUMENS	17648
TOTAL LUMINAIRE EFFICIENCY	72%
LUMINAIRE EFFECIENCY RATING	101
TOTAL LUMINAIRE WATTS	175

FINISHES



PREMIUM FINISHES



NOTE: DISPLAYED FINISHES DIFFER BETWEEN SCREENS AS WELL AS PRINTERS AND MAY NOT ACCURATELY DEPICT COLOR.