

LUNA ZEST™ PENDANT

PROJECT: _____

TYPE: _____

QUANTITY: _____

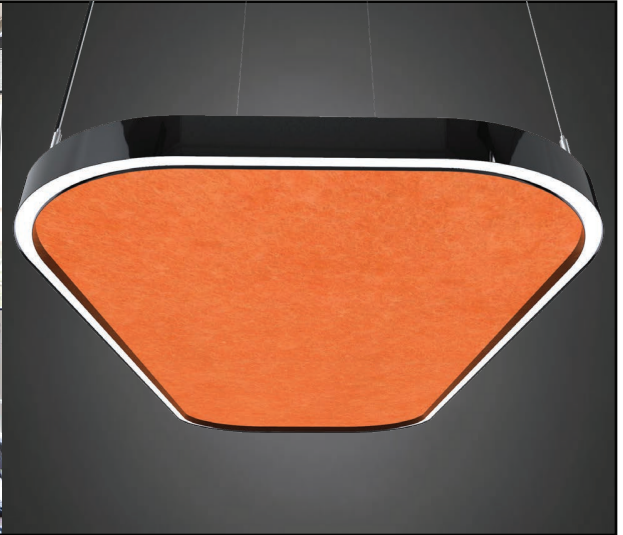
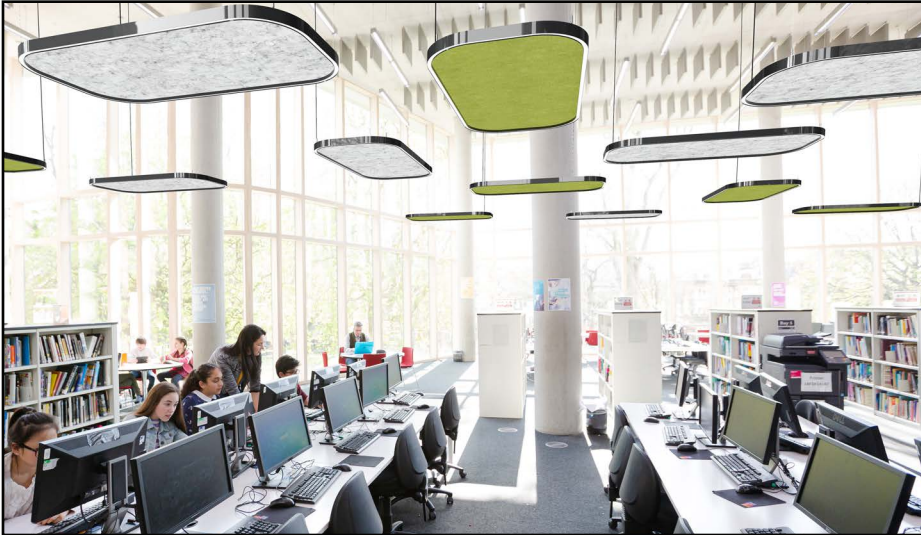

PN: 971LURSP

APPLICATION	<ul style="list-style-type: none"> • PENDANT MOUNT • INDOOR
DIMENSION	<ul style="list-style-type: none"> • LENGTH: 60", 72", 84", AND 96" (152CM, 183CM, 213CM, AND 244CM) • WIDTH: 38" AND 48" (97CM AND 122CM)
ILLUMINATION	<ul style="list-style-type: none"> • DIRECT OR INDIRECT/DIRECT • LED 90CRI • 4,483 - 14,000 LUMENS
DRIVER	<ul style="list-style-type: none"> • 120V, 277V, AND 347V • 10KA SURGE SUPPRESSION STANDARD
DIFFUSERS	<ul style="list-style-type: none"> • HIGH EFFICIENCY ACRYLIC
MOUNTING	<ul style="list-style-type: none"> • 96" (244CM) BLACK OR WHITE DROP CORD W/ AIRCRAFT CABLE
CONSTRUCTION	<ul style="list-style-type: none"> • ALUMINUM
FINISHES	<ul style="list-style-type: none"> • AVAILABLE IN SEVERAL TMS POWDER COATED FINISHES • CUSTOM RAL FINISHES AVAILABLE
DIMMING	<ul style="list-style-type: none"> • 0 - 10V STANDARD DIMMING • LUTRON HI - LUME (1%)
WEIGHT	<ul style="list-style-type: none"> • 43 LBS MAXIMUM

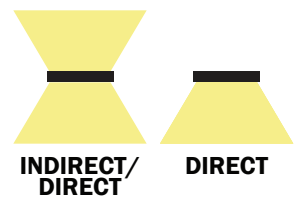

LUNA ZEST™ PENDANT

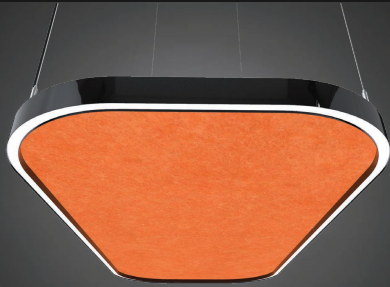

PROJECT: _____

TYPE: _____

QUANTITY: _____

971LURSP

1 2 3 4 5 6 7 8 9 10

1.										
DIRECT										
LENGTH (L X W)	5L3WD	6L3WD	7L3WD	7L4WD	8L3WD	8L4WD				
	60"X36"	72"X36"	84"X36"	84"X48"	96"X36"	96"X48"				
LED (W)	48W	55W	63W	70W	70W	77W				
LUMENS	4483	5167	5859	6547	6547	7240				
INDIRECT/DIRECT										
LENGTH (L X W)	5L3WID	6L3WID	7L3WID	7L4WID	8L3WID	8L4WID				
	60"X36"	72"X36"	84"X36"	84"X48"	96"X36"	96"X48"				
LED (W)	96W	111W	125W	140W	140W	155W				
LUMENS	8480	9862	11240	12581	12581	14000				
2.		H		M		L		C: ¹		
OUTPUT	100% LUMENS		75% LUMENS		50% LUMENS		[CUSTOM]% LUMENS			
3.										
ACOUSTIC COLOR	CW	MA	CA	RH	SG	HG	SL	CH		
	COCONUT WHITE	MARBLE	CAPPUCCINO	RHINO GREY	STEEL GREY	HEATHER GREY	SLATE	CHARCOAL		
	TA	RR	MT	GG	GA	LB	DO	CG		
	TANGERINE	RUBY RED	MANGO TWIST	GOLF GREEN	GREEN APPLE	LINEN BLUE	DEEP OCEAN	CYBER GRAPE		
4.										
LED CCT	30K			35K			40K			
	3000K			3500K			4000K			
5.										
VOLTAGE	120			277			347			
	120V			277V			347V			
6.										
CIRCUIT	S				D					
	SINGLE				DUAL					
7.										
MOUNTING	MM				PS					
	MULTIPLE AIRCRAFT CABLES				SINGLE PLATE W/ AIRCRAFT CABLES					
8.										
CORD	BC				WC					
	BLACK CORD				WHITE DROP CORD					
9.										
FINISH	F04	F05	F09	F15	F16	F18	F21	F31	F33	RAL
	MATTE WHITE	GLOSS WHITE	PEWTER	MATTE BLACK	GLOSS BLACK	SATIN ALUMINUM	ARCH BRONZE	SILVER METALLIC	PYRITE BRONZE	CUSTOM (SPECIFY)
10.										
DIMMING	DIML				DIME					
	LED DIMMING (0 - 10V, CURRENT - SINKING)				LUTRON HI - LUME 1%					

1. CUSTOM PERCENTAGE I.E. 60%. CONSULT FACTORY.

NOTE: SOME OPTIONS MAY NOT BE COMPATIBLE WITH OTHERS. ALL SPECIFICATIONS ARE SUBJECT TO CHANGE WITHOUT NOTICE. CONTACT TMS LIGHTING FOR UPDATED SPECIFICATIONS.

LUNA ZEST™ PENDANT

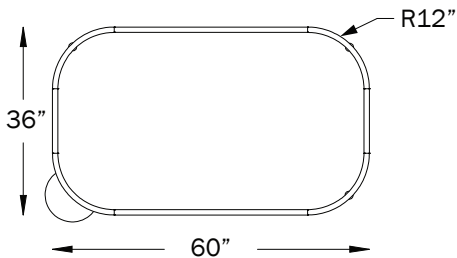

- CANOPY DIAMETER: 10" (25CM)
- WEIGHT D: 13 LBS

5L3W

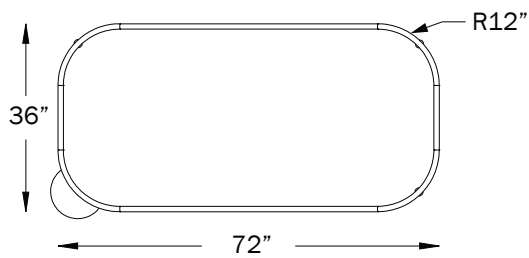

- CANOPY DIAMETER: 10" (25CM)
- WEIGHT D: 13 LBS

6L3W

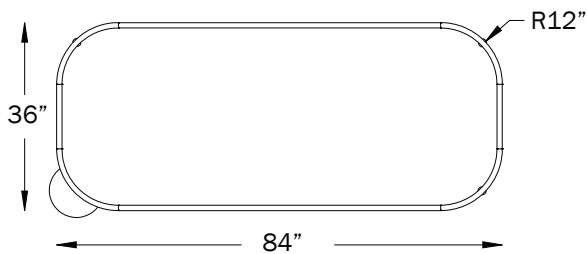

- CANOPY DIAMETER: 10" (25CM)
- WEIGHT D: 13 LBS

7L3W

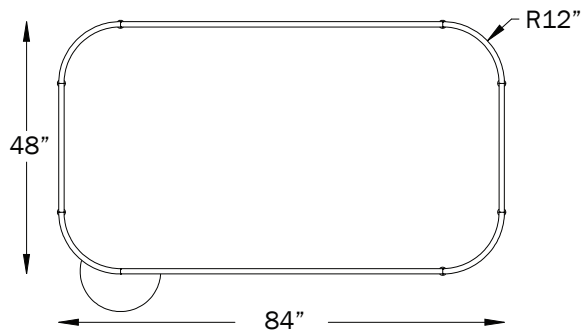

- CANOPY DIAMETER: 10" (25CM)
- WEIGHT D: 13 LBS

7L4W



- CANOPY DIAMETER: 10" (25CM)
- WEIGHT D: 13 LBS

8L3W

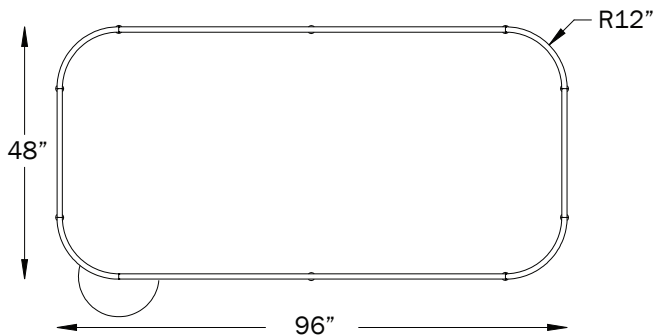

- CANOPY DIAMETER: 10" (25CM)
- WEIGHT D: 13 LBS

8L4W

LUNA ZEST™ PENDANT

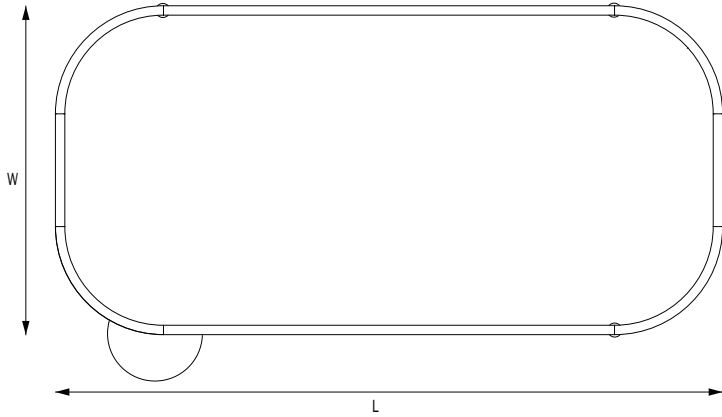

BOTTOM VIEW WITH MM CANOPY

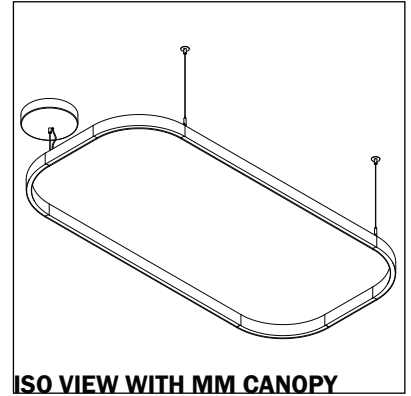

ISO VIEW WITH MM CANOPY

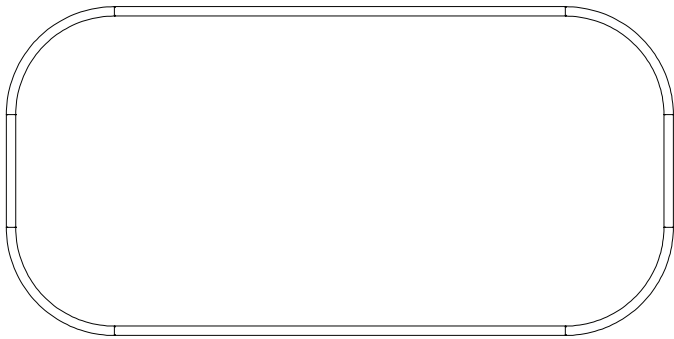

BOTTOM VIEW WITH PS CANOPY

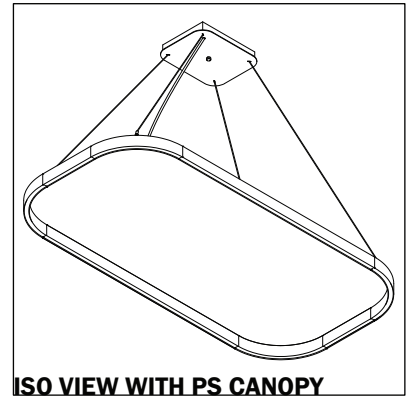

ISO VIEW WITH PS CANOPY

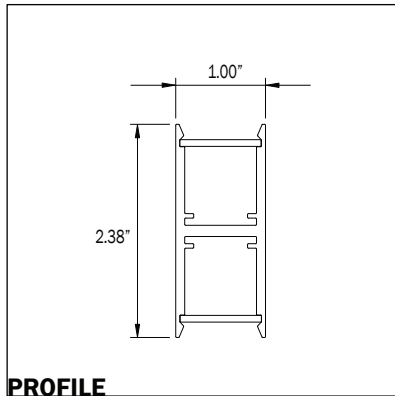

PROFILE

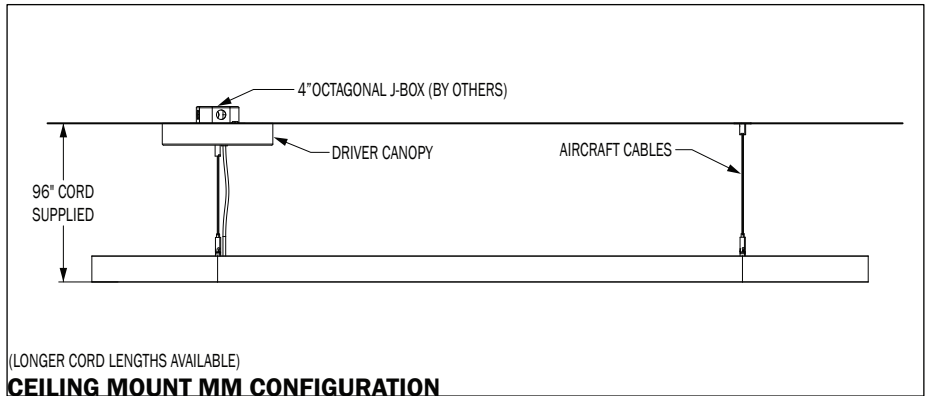

(LONGER CORD LENGTHS AVAILABLE)

CEILING MOUNT MM CONFIGURATION

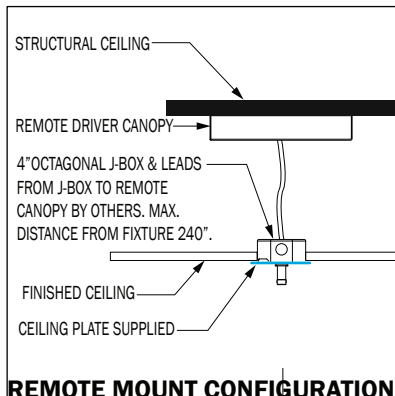

REMOTE MOUNT CONFIGURATION

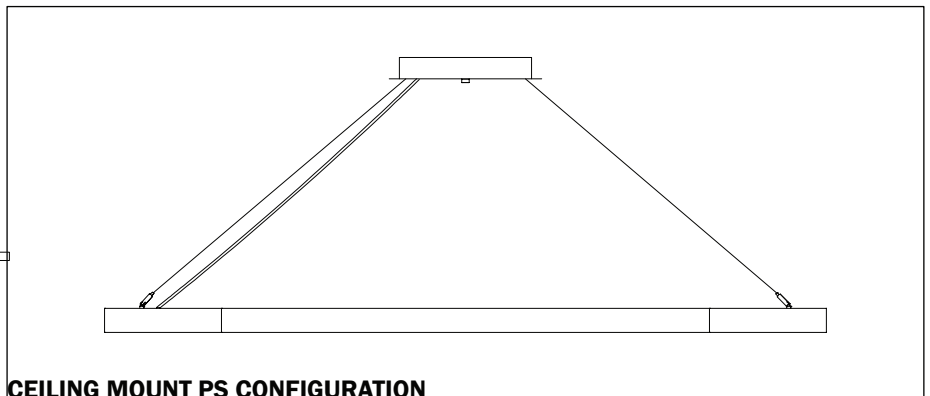

CEILING MOUNT PS CONFIGURATION

DIRECT

PN	SIZE (L X W)	LUMENS	WATTAGE	WEIGHT
941LURP	5L3WD	4483	49	25 LBS
	6L3WD	5167	55	29 LBS
	7L3WD	5859	63	32 LBS
	7L4WD	6547	70	35 LBS
	8L3WD	6547	70	38 LBS
	8L4WD	7240	77	40 LBS

IES INDOOR REPORT

PHOTOMETRIC FILENAME : 941LURSP TA 5L3WD 35K F05.IES

POLAR GRAPH

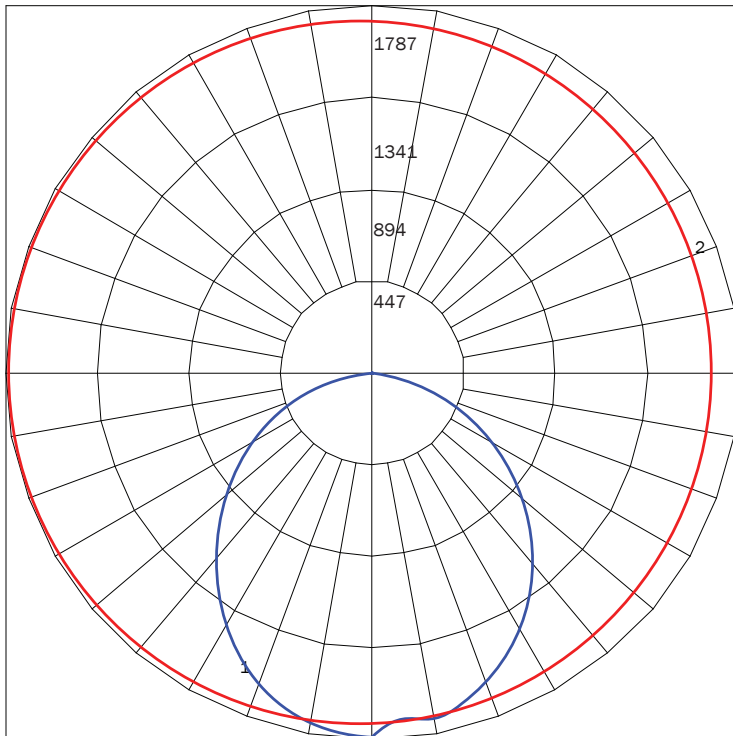

MAXIMUM CANDELA = 1787.39 LOCATED AT HORIZONTAL ANGLE = 180, VERTICAL ANGLE = 5
 # 1 - VERTICAL PLANE THROUGH HORIZONTAL ANGLES (180 - 0) (THROUGH MAX. CD)
 # 2 - HORIZONTAL CONE THROUGH VERTICAL ANGLE (5) (THROUGH MAX. CD)

LUMINAIRE LUMENS	4499
TOTAL LUMINAIRE EFFICIENCY	60%
LUMINAIRE EFFICACY RATING	93
TOTAL LUMINAIRE WATTS	48

INDIRECT / DIRECT

PN	SIZE (L X W)	LUMENS	WATTAGE	WEIGHT
941LURP	5L3WID	8480	96	25 LBS
	6L3WID	9862	111	29 LBS
	7L3WID	11240	125	32 LBS
	7L4WID	12581	140	35 LBS
	8L3WID	12581	140	38 LBS
	8L4WID	14000	155	40 LBS

IES INDOOR REPORT

PHOTOMETRIC FILENAME : 941LURSP TA 8L4WD 35K F05.IES

POLAR GRAPH

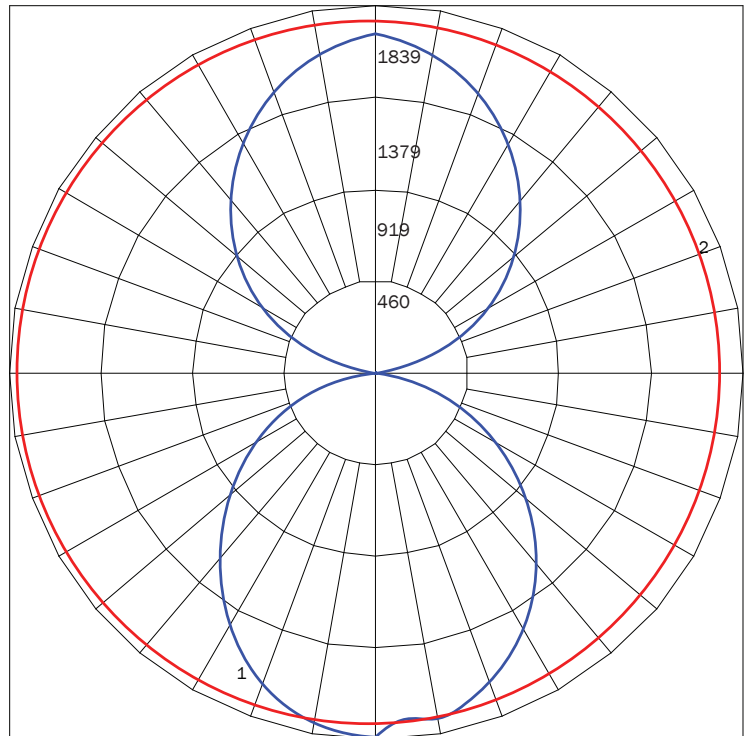

MAXIMUM CANDELA = 1838.81 LOCATED AT HORIZONTAL ANGLE = 180, VERTICAL ANGLE = 5
 # 1 - VERTICAL PLANE THROUGH HORIZONTAL ANGLES (180 - 0) (THROUGH MAX. CD)
 # 2 - HORIZONTAL CONE THROUGH VERTICAL ANGLE (5) (THROUGH MAX. CD)

LUMINAIRE LUMENS	8766
TOTAL LUMINAIRE EFFICIENCY	58%
LUMINAIRE EFFICACY RATING	91
TOTAL LUMINAIRE WATTS	185

AVAILABLE FINISHES



F04
MATTE
WHITE



F05
GLOSS
WHITE



F09
PEWTER



F15
MATTE
BLACK



F16
GLOSS
BLACK



F18
SATIN
ALUMINUM



F21
ARCH
BRONZE



F31
SILVER
METALLIC



F33
PYRITE
BRONZE



RAL
CUSTOM
COLOR
(RAL #)

ACOUSTIC COLOURS



CW
COCONUT
WHITE



MA
MARBLE



CA
CAPPUCCINO

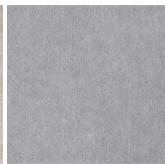

RG
RHINO
GREY



SG
STEEL
GREY



HG
HEATHER
GREY

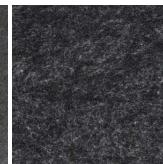

SL
SLATE

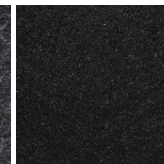

CH
CHARCOAL

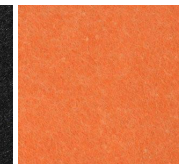

TA
TANGERINE

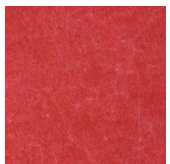

RR
RUBY
RED

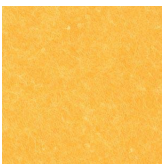

MT
MANGO
TWIST



GG
GOLF
GREEN

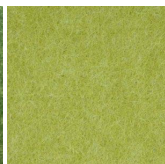

GA
GREEN
APPLE

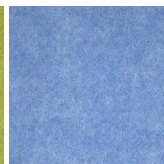

LB
LINEN
BLUE

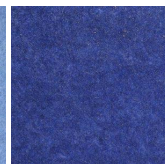

DO
DEEP
OCEAN



CG
CYBER
GRAPE

NOTE: DISPLAYED FINISHES DIFFER BETWEEN SCREENS AS WELL AS PRINTERS AND MAY NOT ACCURATELY DEPICT COLOR.