

LUNA QUDO ACOUSTIC™ PENDANT

PROJECT: _____

TYPE: _____

QUANTITY: _____

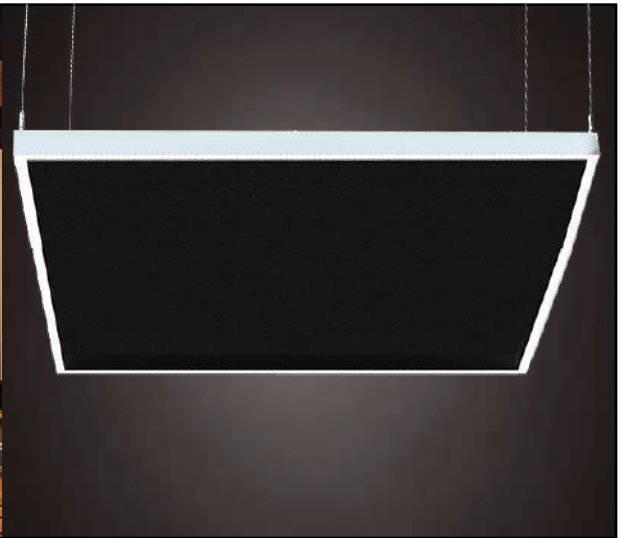

PN: 971LUQP

| | |
|---------------------|---|
| ILLUMINATION | <ul style="list-style-type: none"> • 2,843 - 11,243 LUMENS • DIRECT OR INDIRECT/DIRECT • LED 90CRI |
| APPLICATION | <ul style="list-style-type: none"> • DIRECT OR DIRECT/INDIRECT PENDANT MOUNT • INDOOR RATED |
| DIMENSION | <ul style="list-style-type: none"> • 24", 36", 48" SIZES (61cm, 92cm, and 122cm) • PROFILE: 1"W X 2.625"H (2.54cm X 6.6675cm) |
| ELECTRICAL | <ul style="list-style-type: none"> • 120 - 277V • 10KV SURGE SUPPRESSION |
| DIFFUSERS | <ul style="list-style-type: none"> • HIGH EFFICIENCY ACRYLIC |
| MOUNTING | <ul style="list-style-type: none"> • 120" (304.8cm) BLACK OR WHITE DROP CORD WITH AIRCRAFT CABLES • 120" (304.8cm) POWER OVER SUSPENSION |
| LED DRIVER | <ul style="list-style-type: none"> • CANOPY OR REMOTE MOUNT |
| CONSTRUCTION | <ul style="list-style-type: none"> • ALUMINUM |
| FINISHES | <ul style="list-style-type: none"> • AVAILABLE IN SEVERAL TMS POWDER COATED FINISHES • CUSTOM RAL FINISHES AVAILABLE |
| DIMMING | <ul style="list-style-type: none"> • 0 - 10V (1%) DIMMING (120-277V) • LINE VOLTAGE/TRIAC/ELV (120V ONLY) • LUTRON HI-LUME (1%) DIMMING (120-277V) |
| WEIGHT | <ul style="list-style-type: none"> • 17 LBS MINIMUM, 28 LBS MAXIMUM |

FLAT DIFFUSER

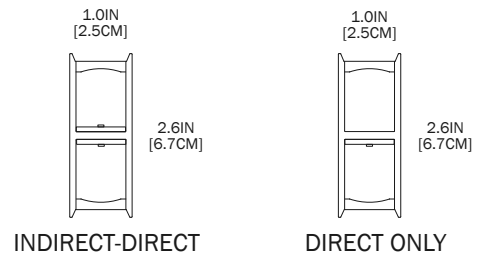

DOM DIFFUSER

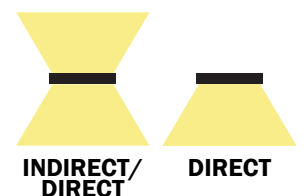
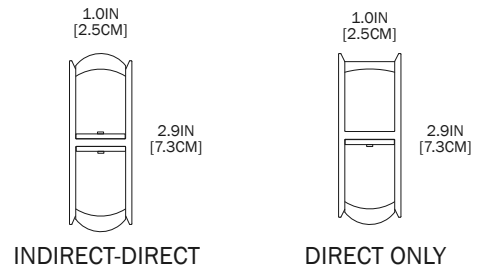

LUNA QUDO ACOUSTIC™ PENDANT

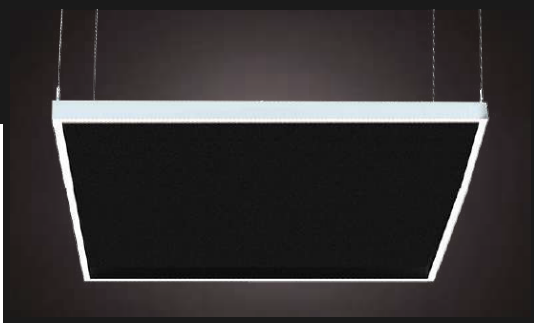

PROJECT: _____

TYPE: _____

QUANTITY: _____

941LUQP

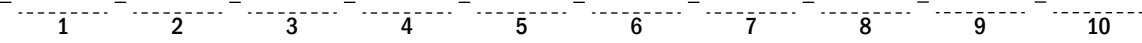

| 1. | DIRECT | | | | | | | | |
|----------------|---|------------|--------------------------------------|-------------|---|------------------------------------|---------------------------------|-----------------|----------------|
| LENGTH | 2D | | 3D | | 4D | | | | |
| | 25" (64CM) | | 37" (94CM) | | 48" (122CM) | | | | |
| LED (W) | 32W | | 48W | | 65W | | | | |
| LUMENS | 2843 | | 4263 | | 5683 | | | | |
| | INDIRECT/DIRECT | | | | | | | | |
| LENGTH | 2ID | | 3ID | | 4ID | | | | |
| | 25" (64CM) | | 37" (94CM) | | 48" (122CM) | | | | |
| LED (W) | 64W | | 96W | | 132W | | | | |
| LUMENS | 5478 | | 8296 | | 11243 | | | | |
| 2. | H | M | | L | C: _____ ¹ | | | | |
| OUTPUT | 100% LUMENS | 75% LUMENS | | 50% LUMENS | [CUSTOM]% LUMENS | | | | |
| 3. | 30K | | 35K | | 40K | | | | |
| CCT | 3000K | | 3500K | | 4000K | | | | |
| 4. | S | | | D | | | | | |
| CIRCUIT | SINGLE | | | DUAL | | | | | |
| 5. | MMCD | | MMRM | | PSCD | | PSRM | | |
| MOUNTING | MULTIPLE CABLES WITH CANOPY DRIVER | | MULTIPLE CABLES WITH REMOTE DRIVER | | SINGLE POINT WITH CANOPY DRIVER | | SINGLE POINT WITH REMOTE DRIVER | | |
| 6. | BC | | WC | | POS | | | | |
| CORD | BLACK DROP CORD WITH AIRCRAFT CABLES | | WHITE DROP CORD WITH AIRCRAFT CABLES | | POWER OVER SUSPENSION (SILVER ONLY) <small>(NOT APPLICABLE FOR MMCD COMBINATION)</small> | | | | |
| 7. | FLAT | | | | DOM | | | | |
| DIFFUSER | FLAT DIFFUSER | | | | DOME DIFFUSER | | | | |
| 8. | CW | | MA | CA | RH | SG | HG | CH | |
| ACOUSTIC COLOR | COCONUT WHITE | | MARBLE | CAPPUCCINO | RHINO GREY | STEEL GREY | HEATHER GREY | CHARCOAL | |
| | TA | RR | MT | GG | GA | LB | DO | CG | |
| | TANGERINE | RUBY RED | MANGO TWIST | GOLF GREEN | GREEN APPLE | LINEN BLUE | DEEP OCEAN | CYBER GRAPE | |
| 9. | ADDITIONAL AND PREMIUM FINISHES AVAILABLE. SEE FINISHES CHART | | F04 | F05 | F15 | F16 | F09 | F31 | F18 |
| FINISH | | | MATTE WHITE | GLOSS WHITE | MATTE BLACK | GLOSS BLACK | PEWTER | SILVER METALLIC | SATIN ALUMINUM |
| 10. | DIML | | DIME | | | DIMV | | | |
| DIMMING | 0-10V (1%) (120-277V) | | LUTRON HI-LUME (1%) (120-277V) | | | LINE VOLTAGE/TRIAC/ELV (120V ONLY) | | | |

1. CUSTOM PERCENTAGE I.E. 60%. CONSULT FACTORY.

NOTE: SOME OPTIONS MAY NOT BE COMPATIBLE WITH OTHERS. ALL SPECIFICATIONS ARE SUBJECT TO CHANGE WITHOUT NOTICE. CONTACT TMS LIGHTING FOR UPDATED SPECIFICATIONS.

LUNA QUDO ACOUSTIC™ PENDANT

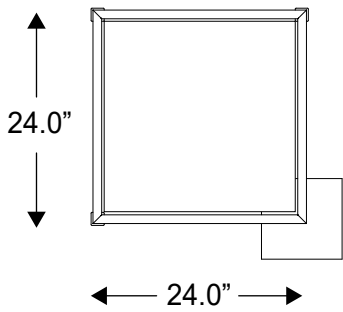

2D / 2ID

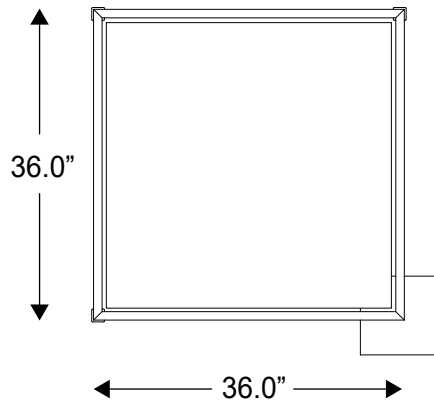

3D / 3ID

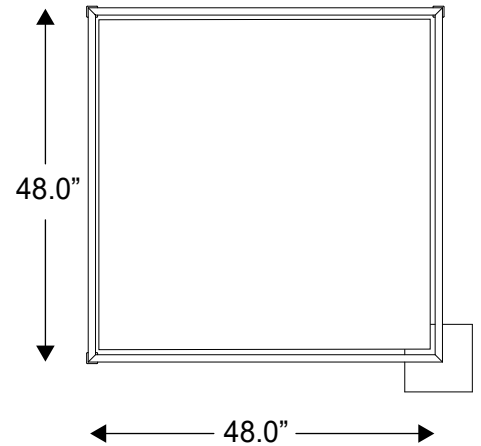

4D / 4ID

| SIZE | ACTUAL SIZE | MOUNTING POINTS | MINIMUM DISTANCE | CANOPY SIZE | | NUMBER OF CANOPY | WEIGHT (POUNDS - LBS) | SECTIONS |
|------|-------------|-----------------|------------------|-------------|-------------|------------------|-----------------------|----------|
| | | | | MMCD | PSCD - PSRM | | | |
| 24 | 24.5" | 4 | 30" | 10" | 10" | 1(D)/ 1(ID) | 17 | 1 |
| 36 | 36.5" | 4 | 50" | 10" | 10" | 1(D)/ 1(ID) | 21 | 1 |
| 48 | 48.5" | 4 | 75" | 10" | 10" | 1(D)/ 1(ID) | 28 | 1 |

LUNA QUDO ACOUSTIC™ PENDANT

POS (POWER OVER SUSPENSION)

MMRM COMBINATION (MULTIPLE CABLES, REMOTE MOUNT DRIVER)

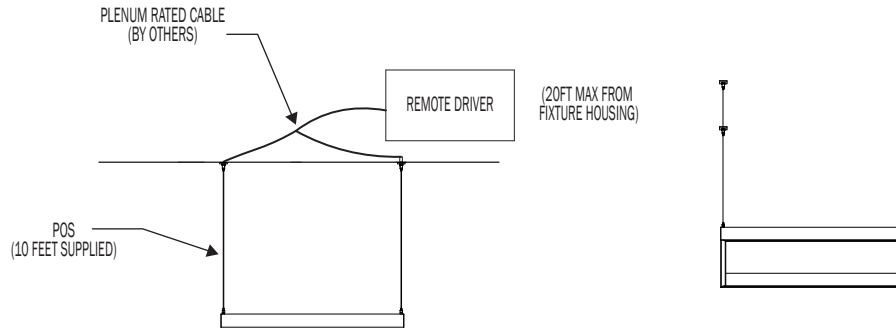

PSCD COMBINATION (SINGLE POINT, CANOPY MOUNT DRIVER)

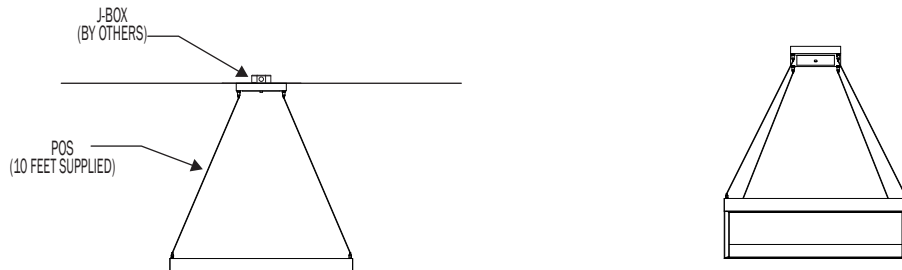

PSRM COMBINATION (SINGLE POINT, REMOTE MOUNT DRIVER)

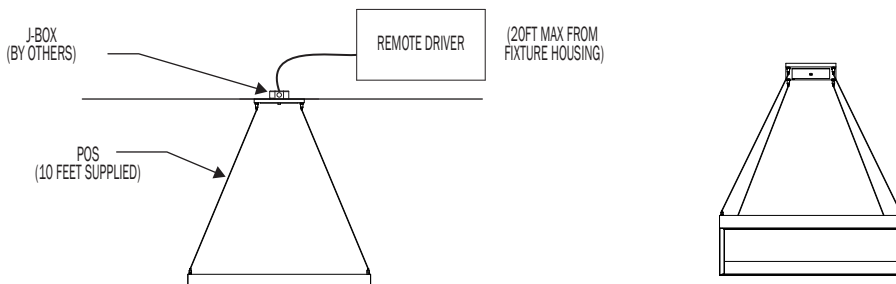

LUNA QUDO ACOUSTIC™ PENDANT

DROP CORD

MMCD COMBINATION (MUTIPLE CABLES, CANOPY MOUNT DRIVER)

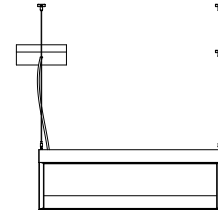
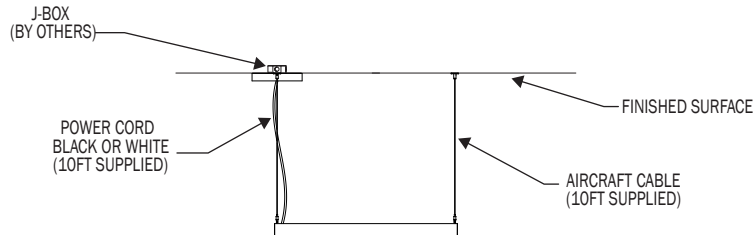

MMRM COMBINATION (MUTIPLE CABLES, REMOTE MOUNT DRIVER)

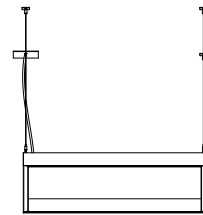
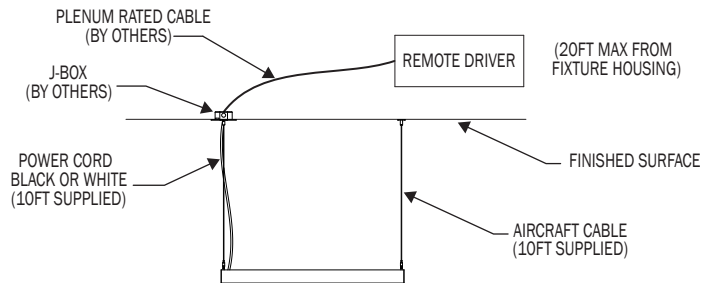

PSCD COMBINATION (SINGLE POINT, CANOPY MOUNT DRIVER)

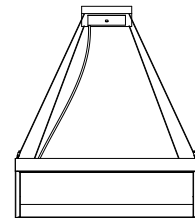
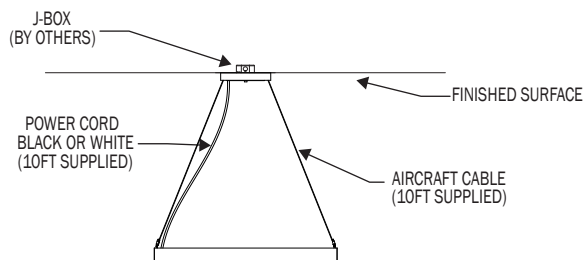

PSRM COMBINATION (SINGLE POINT, REMOTE MOUNT DRIVER)

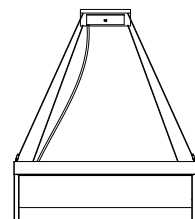
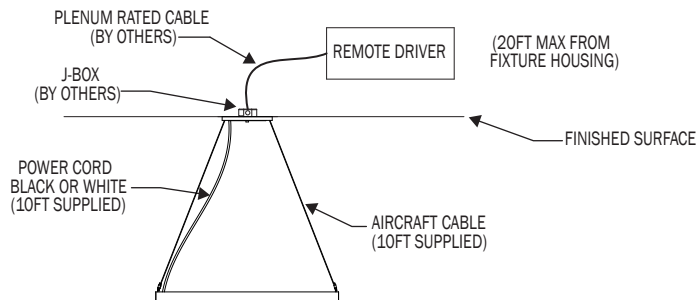

LUNA QUDO ACOUSTIC™ PENDANT

DIRECT

| PN | SIZE (DIA) | LUMENS | WATTAGE | WEIGHT |
|---------|------------|--------|---------|--------|
| 941LUQP | 24D | 2843 | 32 | 17 LBS |
| | 36D | 4263 | 48 | 21 LBS |
| | 48D | 5683 | 65 | 25 LBS |

IES INDOOR REPORT

PHOTOMETRIC FILENAME : 941LUQ 24 D MA 35K F16.IES

POLAR GRAPH

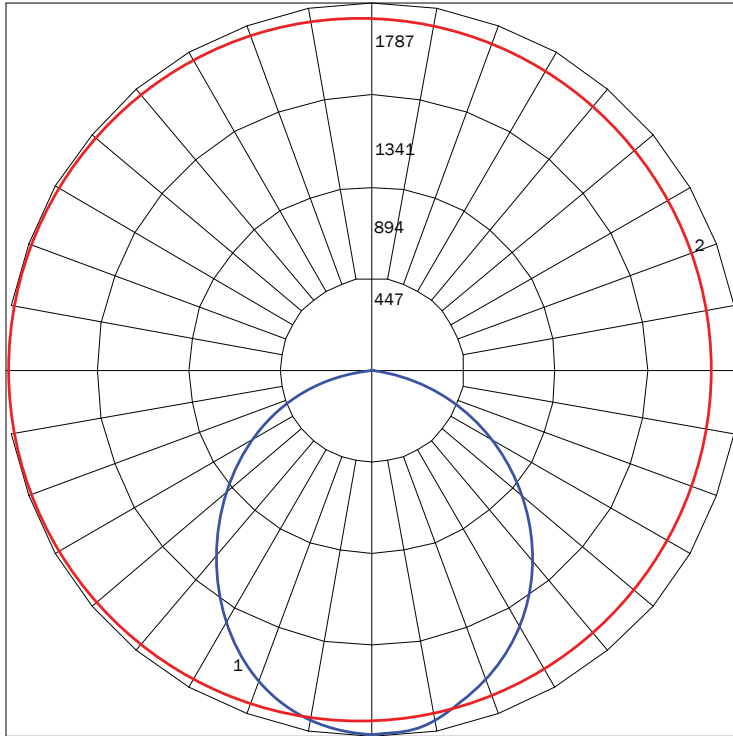

MAXIMUM CANDELA = 1127.49 LOCATED AT HORIZONTAL ANGLE = 0, VERTICAL ANGLE = 5
 # 1 - VERTICAL PLANE THROUGH HORIZONTAL ANGLES (0 - 180) (THROUGH MAX. CD.)
 # 2 - HORIZONTAL CONE THROUGH VERTICAL ANGLE (0) (THROUGH MAX. CD.)

| | |
|-----------------------------------|------|
| LUMINAIRE LUMENS | 3101 |
| TOTAL LUMINAIRE EFFICIENCY | 72% |
| LUMINAIRE EFFICACY RATING | 92 |
| TOTAL LUMINAIRE WATTS | 34 |

INDIRECT / DIRECT

| PN | SIZE (DIA) | LUMENS | WATTAGE | WEIGHT |
|---------|------------|--------|---------|--------|
| 941LUQP | 24D | 5478 | 64 | 20 LBS |
| | 36D | 8296 | 96 | 24 LBS |
| | 48D | 11243 | 132 | 28 LBS |

IES INDOOR REPORT

PHOTOMETRIC FILENAME : 941LUQ 24 ID MA 35K F16.IES

POLAR GRAPH

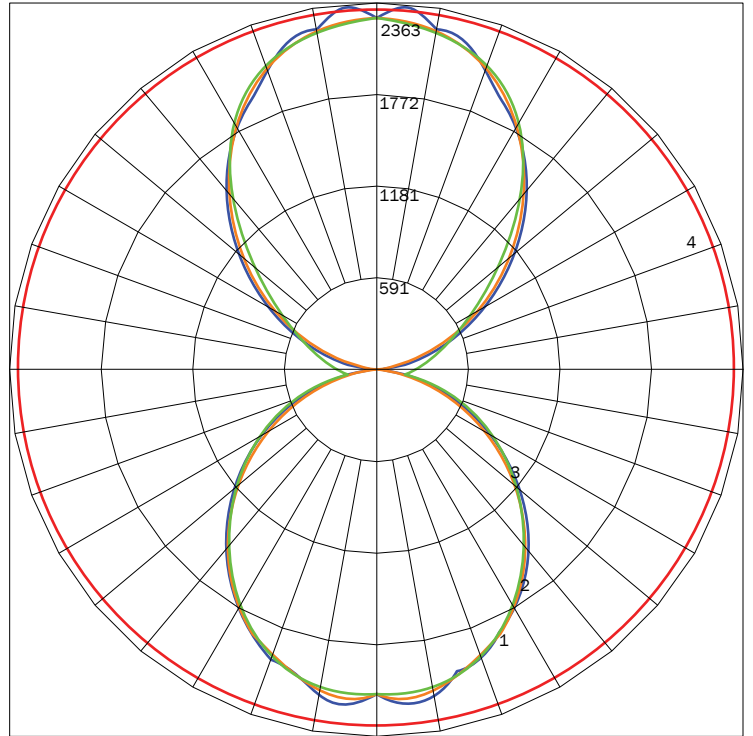

MAXIMUM CANDELA = 2362.96 LOCATED AT HORIZONTAL ANGLE = 0, VERTICAL ANGLE = 175
 # 1 - VERTICAL PLANE THROUGH HORIZONTAL ANGLES (0 - 180) (THROUGH MAX. CD.)
 # 2 - VERTICAL PLANE THROUGH HORIZONTAL ANGLES (45 - 225)
 # 3 - VERTICAL PLANE THROUGH HORIZONTAL ANGLES (90 - 270)
 # 4 - HORIZONTAL CONE THROUGH VERTICAL ANGLE (5) (THROUGH MAX. CD.)

| | |
|-----------------------------------|-------|
| LUMINAIRE LUMENS | 11243 |
| TOTAL LUMINAIRE EFFICIENCY | 54% |
| LUMINAIRE EFFICACY RATING | 85 |
| TOTAL LUMINAIRE WATTS | 132 |

LUNA QUDO ACOUSTIC™ PENDANT

FINISHES



PREMIUM FINISHES



ACOUSTIC COLORS



NOTE: DISPLAYED FINISHES DIFFER BETWEEN SCREENS AS WELL AS PRINTERS AND MAY NOT ACCURATELY DEPICT COLOR.