

QUADRI ACOUSTIC™ PENDANT

PROJECT: _____

TYPE: _____

QUANTITY: _____



PN: 971LURP

APPLICATION	<ul style="list-style-type: none">• PENDANT MOUNT• INDOOR
DIMENSION	<ul style="list-style-type: none">• LENGTH: 24", 36", 48", 60", 72", AND 84" (61CM, 91CM, 122CM, 154CM, 183CM, AND 213CM)• WIDTH: 12", 24", 36", AND 48" (30CM, 61CM, 91CM, 122CM)
ILLUMINATION	<ul style="list-style-type: none">• DIRECT OR INDIRECT/DIRECT• LED 90CRI• 2,049 - 14,578 LUMENS
DRIVER	<ul style="list-style-type: none">• 120V, 277V, AND 347V• 10KA SURGE SUPPRESSION STANDARD
DIFFUSERS	<ul style="list-style-type: none">• HIGH EFFICIENCY ACRYLIC
MOUNTING	<ul style="list-style-type: none">• 96" (244CM) BLACK OR WHITE DROP CORD W/ AIRCRAFT CABLE
CONSTRUCTION	<ul style="list-style-type: none">• ALUMINUM
FINISHES	<ul style="list-style-type: none">• AVAILABLE IN SEVERAL TMS POWDER COATED FINISHES• CUSTOM RAL FINISHES AVAILABLE
DIMMING	<ul style="list-style-type: none">• 0 - 10V STANDARD DIMMING• LUTRON HI - LUME (1%)
WEIGHT	<ul style="list-style-type: none">• 51 LBS MAXIMUM

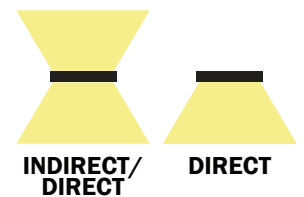

QUADRI ACOUSTIC™ PENDANT



PROJECT: _____

TYPE: _____

QUANTITY: _____

941LURP

1 2 3 4 5 6 7 8 9

1.	DIRECT								
SIZE (L X W)	2L1WD	3L1WD	3L2WD	4L1WD	4L2WD	4L3WD	5L1WD	5L2WD	5L3WD
LED (W)	22W	29W	37W	37W	44W	51W	44W	52W	59W
LUMENS	2049	2734	3423	3425	4117	4803	4115	4812	5508
SIZE (L X W)	5L4WD	6L1WD	6L2WD	6L3WD	6L4WD	7L1WD	7L2WD	7L3WD	7L4WD
LED (W)	66W	52W	59W	66W	74W	59W	66W	77W	81W
LUMENS	6177	4810	5509	6173	6854	5487	6200	6877	7551
	INDIRECT/DIRECT								
SIZE (L X W)	2L1WID	3L1WID	3L2WID	4L1WID	4L2WID	4L3WID	5L1WID	5L2WID	5L3WID
LED (W)	44W	59W	74W	71W	88W	103W	88W	103W	118W
LUMENS	3598	4968	6356	6362	7735	9108	7739	9108	14578
SIZE (L X W)	5L4WID	6L1WID	6L2WID	6L3WID	6L4WID	7L1WID	7L2WID	7L3WID	7L4WID
LED (W)	132W	103W	188W	132W	147W	117W	132W	147W	162W
LUMENS	11861	9113	10479	11858	13248	10491	11842	13248	14578

2.	H	M	L	C: ¹
OUTPUT	100% LUMENS	75% LUMENS	50% LUMENS	[CUSTOM]% LUMENS

3.	CW	MA	CA	RH	SG	HG	SL	CH
ACOUSTIC COLOR	COCONUT WHITE	MARBLE	CAPPUCCINO	RHINO GREY	STEEL GREY	HEATHER GREY	SLATE	CHARCOAL
	TA	RR	MT	GG	GA	LB	DO	CG
	TANGERINE	RUBY RED	MANGO TWIST	GOLF GREEN	GREEN APPLE	LINEN BLUE	DEEP OCEAN	CYBER GRAPE

4.	30K	35K	40K
LED CCT	3000K	3500K	4000K

5.	120	UNI	347
VOLTAGE	120V	120 - 277V	347V

6.	S	D
CIRCUIT	SINGLE	DUAL

7.	BC	WC
CORD	BLACK CORD	WHITE DROP CORD

NOTE: SOME OPTIONS MAY NOT BE COMPATIBLE WITH OTHERS. ALL SPECIFICATIONS ARE SUBJECT TO CHANGE WITHOUT NOTICE. CONTACT TMS LIGHTING FOR UPDATED SPECIFICATIONS.

QUADRI ACOUSTIC™ PENDANT

8.	F04	F05	F09	F15	F16	F18	F21	F31	F33	RAL
FINISH	MATTE WHITE	GLOSS WHITE	PEWTER	MATTE BLACK	GLOSS BLACK	SATIN ALUMINUM	ARCH BRONZE	SILVER METALLIC	PYRITE BRONZE	CUSTOM (SPECIFY)
9.	DIML					DIME				
DIMMING	LED DIMMING (0 - 10V, CURRENT - SINKING)					LUTRON HI - LUME 1%				

1. CUSTOM PERCENTAGE I.E. 60%. CONSULT FACTORY.

QUADRI ACOUSTIC™ PENDANT

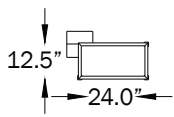

- CANOPY DIAMETER: 9" (23CM)
- WEIGHT D: 13 LBS

2L1W

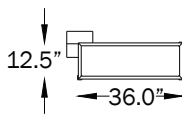

- CANOPY DIAMETER: 9" (23CM)
- WEIGHT D: 15 LBS

3L1W

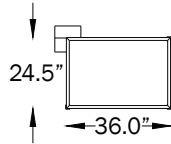

- CANOPY DIAMETER: 9" (23CM)
- WEIGHT D: 17 LBS

3L2W

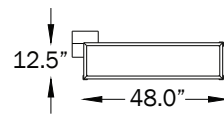

- CANOPY DIAMETER: 9" (23CM)
- WEIGHT D: 22 LBS

4L1W

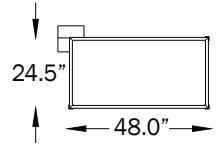

- CANOPY DIAMETER: 9" (23CM)
- WEIGHT D: 24 LBS

4L2W

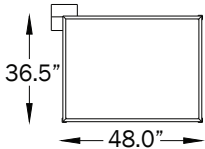

- CANOPY DIAMETER: 10" (25CM)
- WEIGHT D: 26 LBS

4L3W

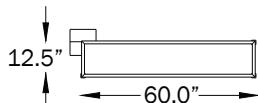

- CANOPY DIAMETER: 9" (23CM)
- WEIGHT D: 25 LBS

5L1W

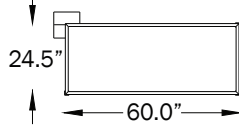

- CANOPY DIAMETER: 10" (25CM)
- WEIGHT D: 27 LBS

5L2W

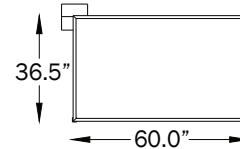

- CANOPY DIAMETER: 10" (25CM)
- WEIGHT D: 33 LBS

5L3W

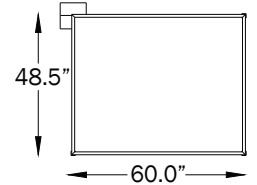

- CANOPY DIAMETER: 10" (25CM)
- WEIGHT D: 39 LBS

5L4W

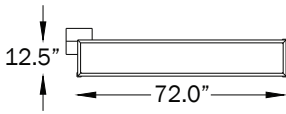

- CANOPY DIAMETER: 10" (25CM)
- WEIGHT D: 28 LBS

6L1W

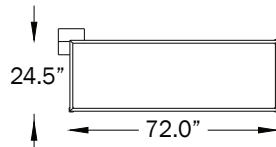

- CANOPY DIAMETER: 10" (25CM)
- WEIGHT D: 30 LBS

6L2W

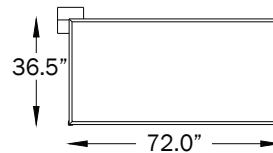

- CANOPY DIAMETER: 10" (25CM)
- WEIGHT D: 36 LBS

6L3W

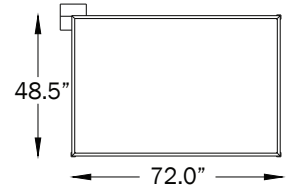

- CANOPY DIAMETER: 10" (25CM)
- WEIGHT D: 42 LBS

6L4W

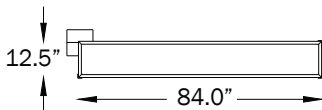

- CANOPY DIAMETER: 10" (25CM)
- WEIGHT D: 45 LBS

7L1W

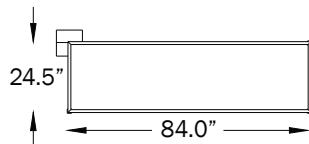

- CANOPY DIAMETER: 10" (25CM)
- WEIGHT D: 31 LBS

7L2W

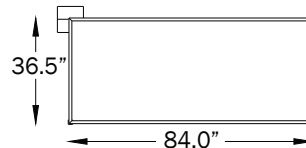

- CANOPY DIAMETER: 10" (25CM)
- WEIGHT D: 35 LBS

7L3W

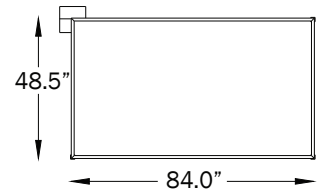

- CANOPY DIAMETER: 10" (25CM)
- WEIGHT D: 40 LBS

7L4W

QUADRI ACOUSTIC™ PENDANT

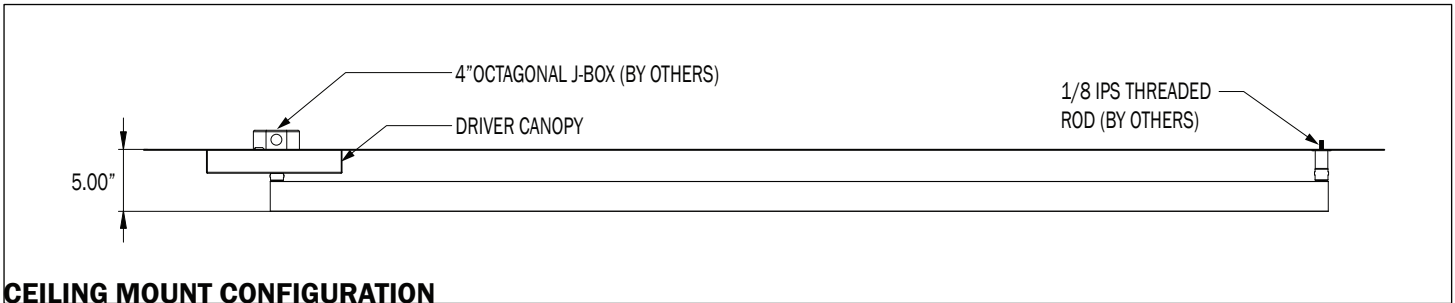
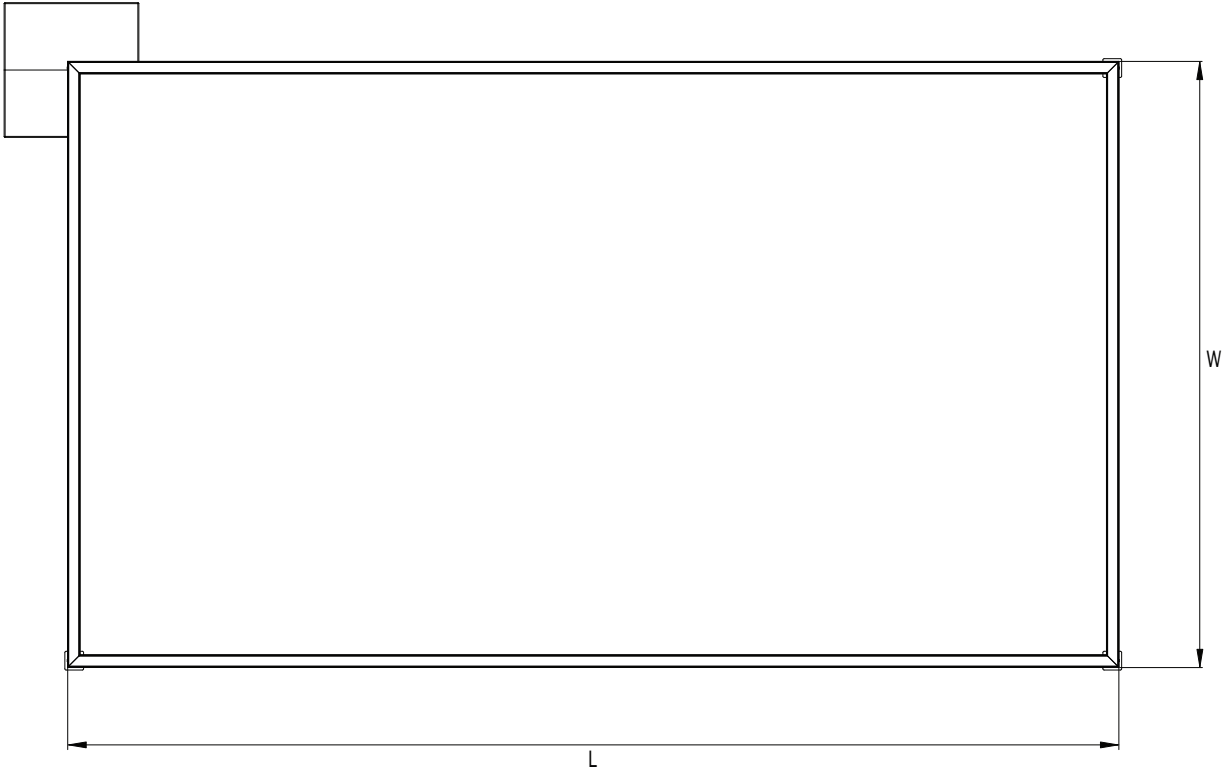

CEILING MOUNT CONFIGURATION

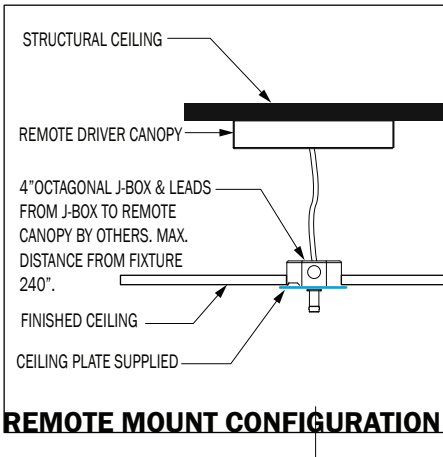

REMOTE MOUNT CONFIGURATION

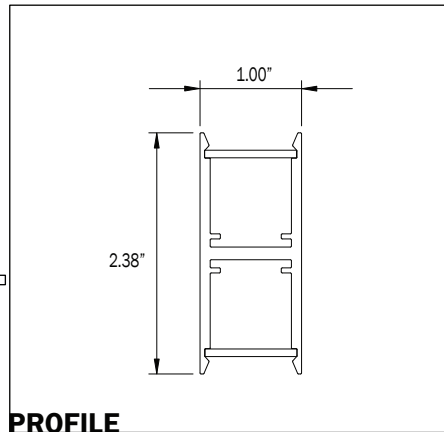

PROFILE

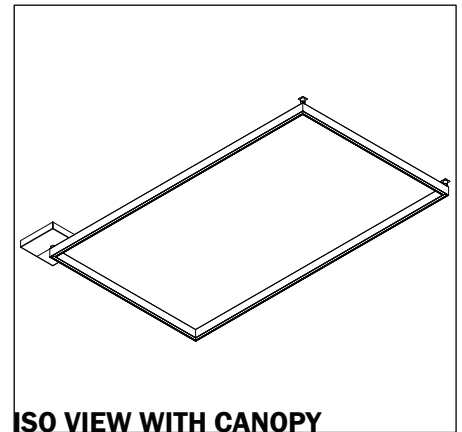

ISO VIEW WITH CANOPY

QUADRI ACOUSTIC™ PENDANT

DIRECT

PN	SIZE (L X W)	LUMENS	WATTAGE	WEIGHT
941LURP	2L1WD	2049	22	13 LBS
	3L1WD	2734	29	15 LBS
	3L2WD	3423	37	17 LBS
	4L1WD	3425	37	22 LBS
	4L2WD	4117	44	24 LBS
	4L3WD	4803	51	26 LBS
	5L1WD	4115	44	25 LBS
	5L2WD	4812	52	27 LBS
	5L3WD	5508	59	33 LBS
	5L4WD	6177	66	39 LBS
	6L1WD	4810	52	28 LBS
	6L2WD	5509	59	30 LBS
	6L3WD	6173	66	36 LBS
	6L4WD	6854	74	42 LBS
	7L1WD	5487	59	45 LBS
	7L2WD	6200	66	34 LBS
7L3WD	6877	77	35 LBS	
7L4WD	7551	81	40 LBS	

INDIRECT / DIRECT

PN	SIZE (L X W)	LUMENS	WATTAGE	WEIGHT
941LURP	2L1WID	3598	44	13 LBS
	3L1WID	4968	59	15 LBS
	3L2WID	6356	74	17 LBS
	4L1WID	6362	71	22 LBS
	4L2WID	7735	88	24 LBS
	4L3WID	9108	103	26 LBS
	5L1WID	7739	88	25 LBS
	5L2WID	9108	103	27 LBS
	5L3WID	10486	118	33 LBS
	5L4WID	11861	132	39 LBS
	6L1WID	9113	103	28 LBS
	6L2WID	10479	118	30 LBS
	6L3WID	11858	132	36 LBS
	6L4WID	13248	147	42 LBS
	7L1WID	10491	117	45 LBS
	7L2WID	11842	132	34 LBS
7L3WID	13248	147	35 LBS	
7L4WID	14578	162	40 LBS	

QUADRI ACOUSTIC™ PENDANT

IES INDOOR REPORT
PHOTOMETRIC FILENAME : 941LURP 2L1WD RR 35K F05.IES

POLAR GRAPH

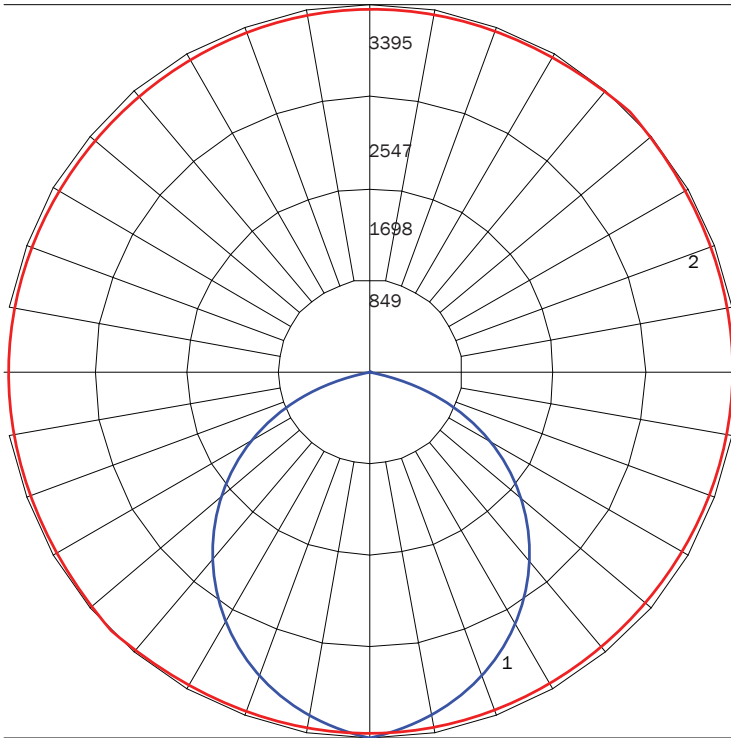

MAXIMUM CANDELA = 3395.47 LOCATED AT HORIZONTAL ANGLE = 180, VERTICAL ANGLE = 0
 # 1 - VERTICAL PLANE THROUGH HORIZONTAL ANGLES (180 - 0) (THROUGH MAX. CD)
 # 2 - HORIZONTAL CONE THROUGH VERTICAL ANGLE (5) (THROUGH MAX. CD)

LUMINAIRE LUMENS	8923
TOTAL LUMINAIRE EFFICIENCY	60%
LUMINAIRE EFFICACY RATING	93
TOTAL LUMINAIRE WATTS	96

IES INDOOR REPORT
PHOTOMETRIC FILENAME : 941LURP 7L4WID RR 35K F05.IES

POLAR GRAPH

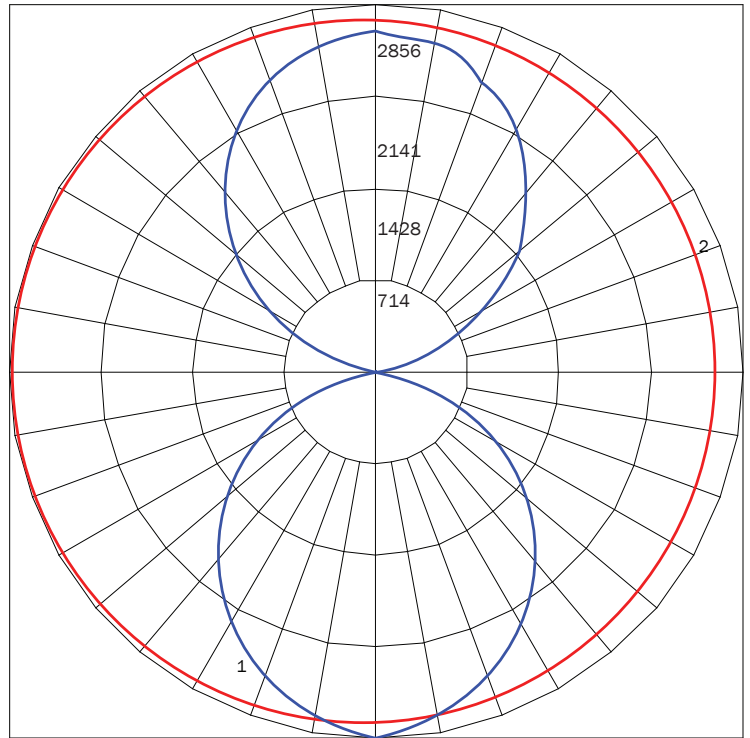

MAXIMUM CANDELA = 2856.1 LOCATED AT HORIZONTAL ANGLE = 157.5, VERTICAL ANGLE = 10
 # 1 - VERTICAL PLANE THROUGH HORIZONTAL ANGLES (157.5 - 337.5) (THROUGH MAX. CD)
 # 2 - HORIZONTAL CONE THROUGH VERTICAL ANGLE (10) (THROUGH MAX. CD)

LUMINAIRE LUMENS	14578
TOTAL LUMINAIRE EFFICIENCY	58%
LUMINAIRE EFFICACY RATING	90
TOTAL LUMINAIRE WATTS	162

QUADRI ACOUSTIC™ PENDANT

AVAILABLE FINISHES



F04
MATTE
WHITE



F05
GLOSS
WHITE



F09
PEWTER



F15
MATTE
BLACK



F16
GLOSS
BLACK



F18
SATIN
ALUMINUM



F21
ARCH
BRONZE



F31
SILVER
METALLIC



F33
PYRITE
BRONZE



RAL
CUSTOM
COLOR
(RAL #)

ACOUSTIC COLOURS

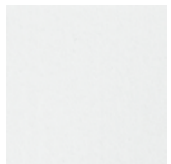

CW
COCONUT
WHITE



MA
MARBLE



CA
CAPPUCINO

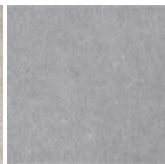

RG
RHINO
GREY



SG
STEEL
GREY



HG
HEATHER
GREY

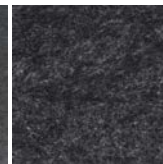

SL
SLATE

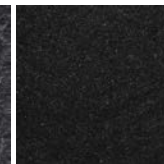

CH
CHARCOAL

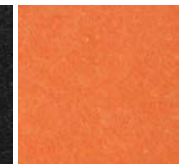

TA
TANGERINE

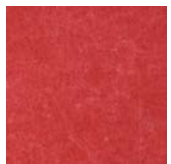

RR
RUBY
RED



MT
MANGO
TWIST

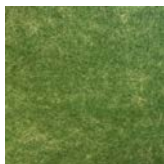

GG
GOLF
GREEN

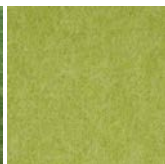

GA
GREEN
APPLE



LB
LINEN
BLUE

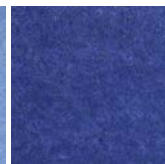

DO
DEEP
OCEAN



CG
CYBER
GRAPE

NOTE: DISPLAYED FINISHES DIFFER BETWEEN SCREENS AS WELL AS PRINTERS AND MAY NOT ACCURATELY DEPICT COLOR.