

LUNA QUADRI™ CEILING

PROJECT: _____

TYPE: _____

QUANTITY: _____



PN: 941LUCL

APPLICATION	<ul style="list-style-type: none">• DIRECT CEILING• INDOOR RATED
DIMENSION	<ul style="list-style-type: none">• AVAILABLE IN 24"- 84" LENGTHS AND 12"- 84" WIDTHS• CUSTOM SIZES AVAILABLE
ILLUMINATION	<ul style="list-style-type: none">• LED 90CRI• 4483 - 7930 LUMENS
ELECTRICAL	<ul style="list-style-type: none">• 120 - 277V• 6KV SURGE SUPPRESSION STANDARD
DIFFUSERS	<ul style="list-style-type: none">• HIGH EFFICIENCY ACRYLIC
MOUNTING	<ul style="list-style-type: none">• REMOTE OR CEILING MOUNTED CANOPY
CONSTRUCTION	<ul style="list-style-type: none">• ALUMINUM
FINISHES	<ul style="list-style-type: none">• AVAILABLE IN SEVERAL TMS POLYESTER POWDER COATED FINISHES• CUSTOM RAL FINISHES AVAILABLE
DIMMING	<ul style="list-style-type: none">• 0 - 10V STANDARD
WEIGHT	<ul style="list-style-type: none">• 51 LBS MAXIMUM

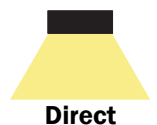

Direct

LUNA QUADRI™ CEILING



PROJECT: _____

TYPE: _____

QUANTITY: _____

941LUCL -

1 2 3 4 5 6 7

1.	2L1W	3L1W	3L2W	4L1W	4L2W	4L3W	5L1W	5L2W	5L3W	5L4W	6L1W
L"xW"	24x12	36x12	36x24	48x12	48x24	48x36	60x12	60x24	60x36	60x48	72x12
LED (W)	22	29	37	37	44	51	44	52	59	66	52
LUMENS	2049	2734	3423	3425	4117	4803	4115	4812	5508	6177	4810
PN	6L2W	6L3W	6L4W	6L5W	7L1W	7L2W	7L3W	7L4W	7L5W	7L6W	CUS
L"xW"	72x24	72x36	72x48	72x60	84x12	84x24	84x36	84x48	84x60	84x72	CUSTOM SIZE (SPECIFY LXW)
LED (W)	59	66	74	81	59	66	77	81	88	96	
LUMENS	5509	6173	6854	7548	5487	6200	6877	7551	8234	8923	

2.	H	M	L	C ¹
OUTPUT	100% LUMEN OUTPUT	75% LUMEN OUTPUT	50% LUMEN OUTPUT	[CUSTOM] % LUMEN OUTPUT

3.	30K	35K	40K
CCT	3000	3500	4000

4.	120	UNI	347
VOLTAGE	120V	120V - 277V	347V

5.	CD	RM
DRIVER	CANOPY MOUNT	REMOTE MOUNT

6.	F04	F05	F09	F15	F16	F18	F21	F31	F33	RAL
FINISH	MATTE WHITE	GLOSS WHITE	PEWTER	MATTE BLACK	GLOSS BLACK	SATIN ALUMINUM	ARCH BRONZE	SILVER METALLIC	PYRITE BRONZE	CUSTOM (SPECIFY)

7.	DIML	DIME
DIMMING	STANDARD 0-10V	LUTRON HI-LUME (1%)

NOTE: SOME OPTIONS MAY NOT BE COMPATIBLE WITH OTHERS. ALL SPECIFICATIONS ARE SUBJECT TO CHANGE WITHOUT NOTICE. CONTACT TMS LIGHTING FOR UPDATED SPECIFICATIONS.

LUNA QUADRI™ CEILING

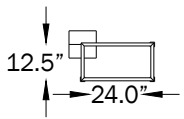

2L1W

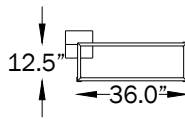

3L1W

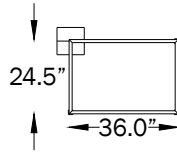

3L2W

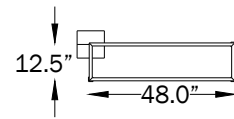

4L1W

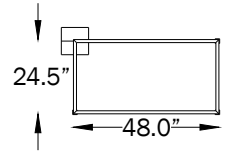

4L2W

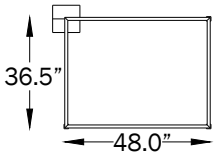

4L3W

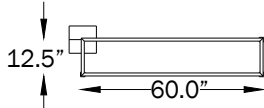

5L1W

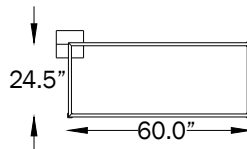

5L2W

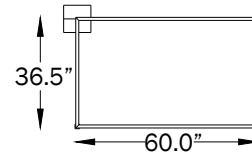

5L3W

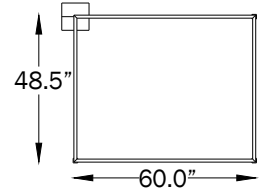

5L4W

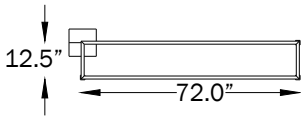

6L1W

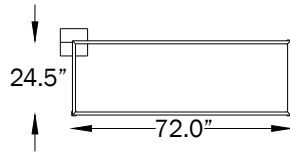

6L2W

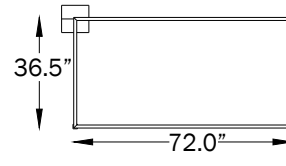

6L3W

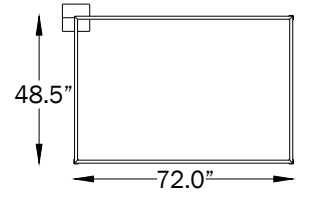

6L4W

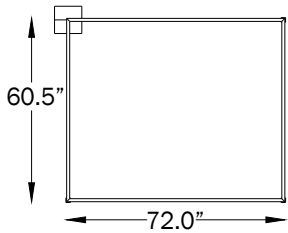

6L5W

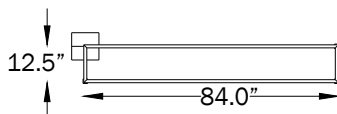

7L1W

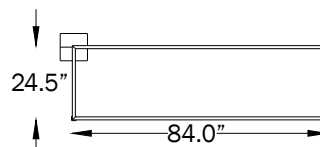

7L2W

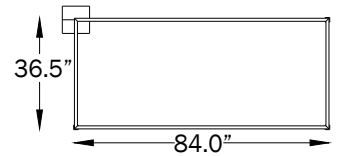

7L3W

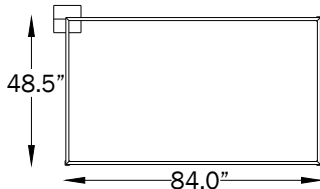

7L4W

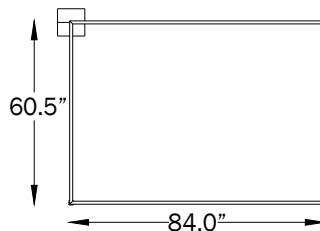

7L5W

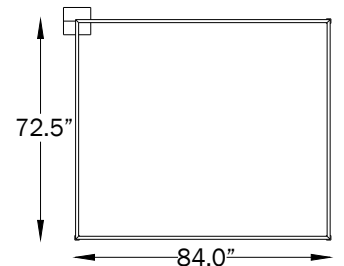

7L6W

LUNA QUADRI™ CEILING

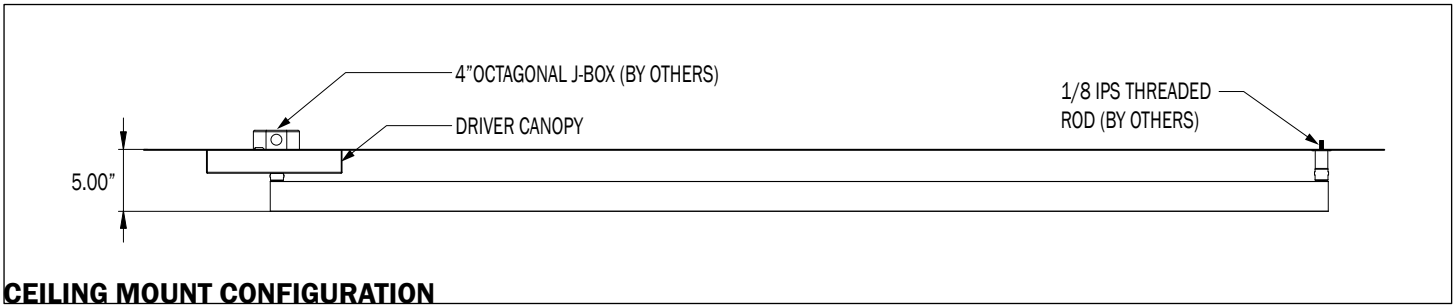
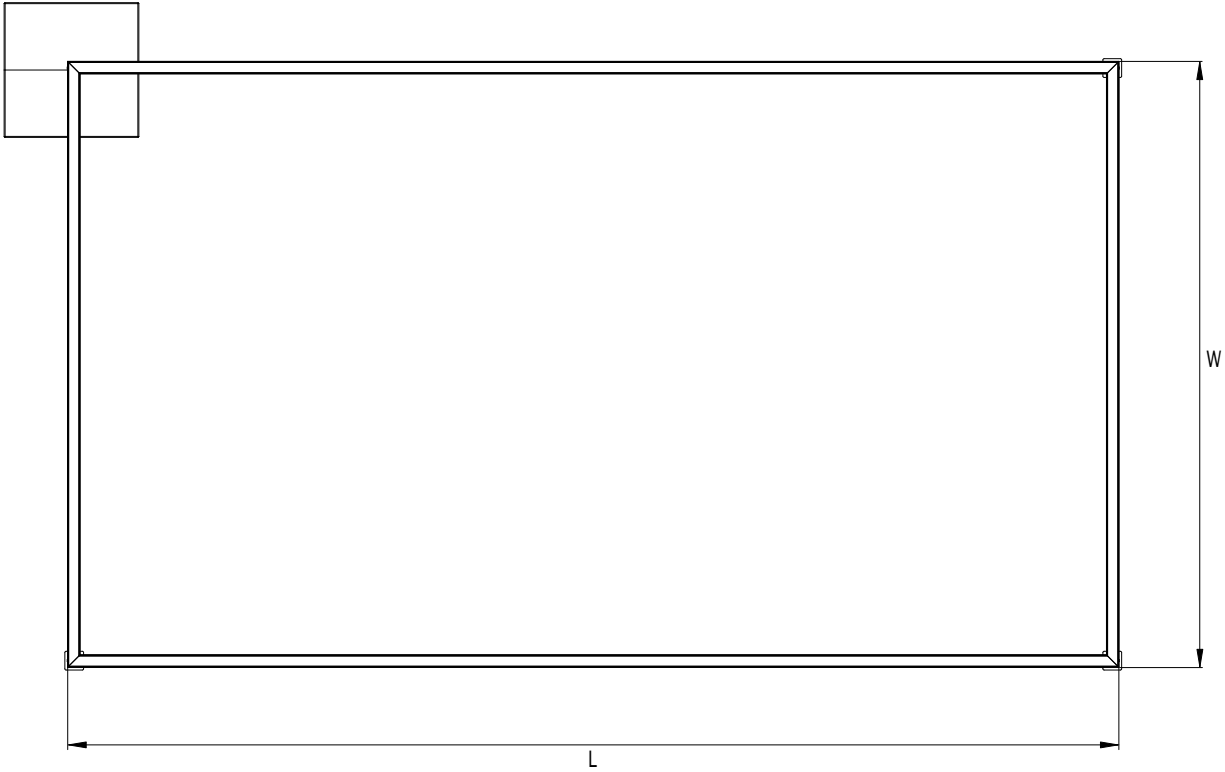

CEILING MOUNT CONFIGURATION

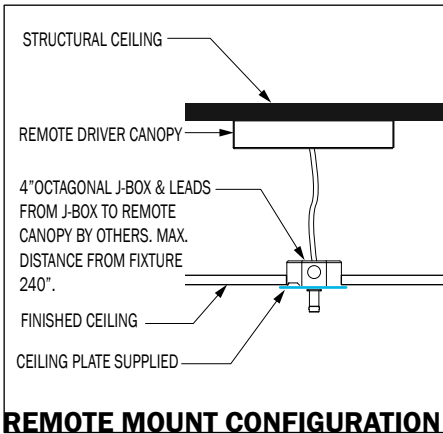

REMOTE MOUNT CONFIGURATION

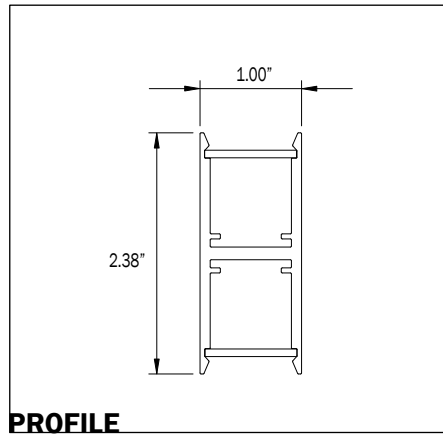

PROFILE

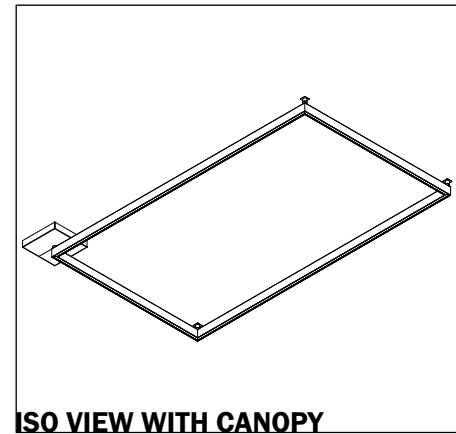

ISO VIEW WITH CANOPY

DIRECT

PN (INCH)	LUMENS	WATTAGE	CANOPY DIA	WEIGHT
2L1WD	2049	22	9"	13 LBS
3L1WD	2734	29	9"	15 LBS
3L2WD	3423	37	9"	17 LBS
4L1WD	3425	37	9"	22 LBS
4L2WD	4117	44	9"	24 LBS
4L3WD	4803	51	10"	26 LBS
5L1WD	4115	44	9"	25 LBS
5L2WD	4812	52	10"	27 LBS
5L3WD	5508	59	10"	33 LBS
5L4WD	6177	66	10"	39 LBS
6L1WD	4810	52	10"	28 LBS
6L2WD	5509	59	10"	30 LBS
6L3WD	6173	66	10"	36 LBS
6L4WD	6854	74	10"	42 LBS
6L5WD	7548	81	10"	45 LBS
7L1WD	5487	59	10"	45 LBS
7L2WD	6200	66	10"	31 LBS
7L3WD	6877	77	10"	35 LBS
7L4WD	7551	81	10"	40 LBS
7L5WD	8234	88	10"	48 LBS
7L6WD	8923	96	10"	51 LBS

IES INDOOR REPORT

PHOTOMETRIC FILENAME : 941LURCL L2W1D 35K F05.IES

POLAR GRAPH

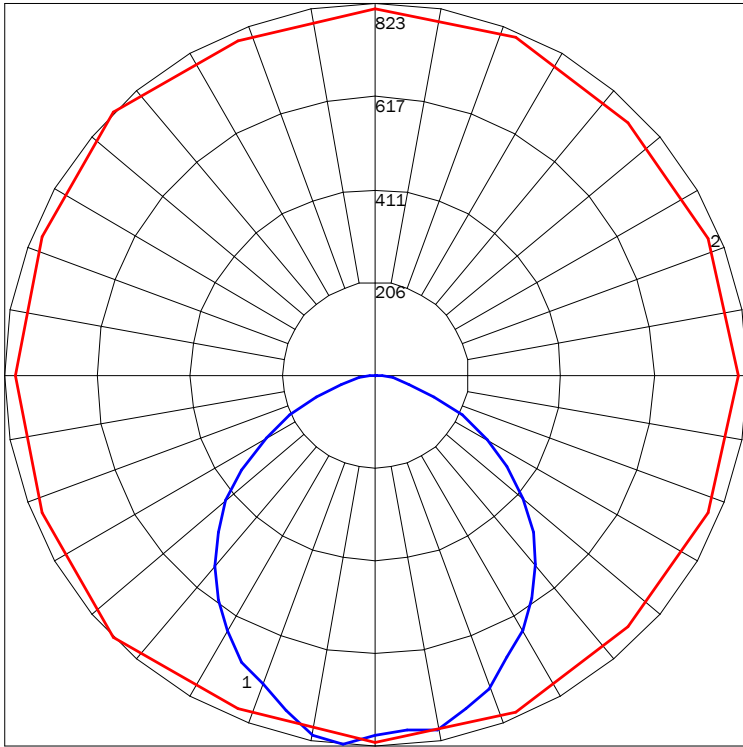

MAXIMUM CANDELA = 822.85 LOCATED AT HORIZONTAL ANGLE = 135, VERTICAL ANGLE = 5
 # 1 - VERTICAL PLANE THROUGH HORIZONTAL ANGLES (135 - 315) (THROUGH MAX. CD.)
 # 2 - HORIZONTAL CONE THROUGH VERTICAL ANGLE (5) (THROUGH MAX. CD.)

LUMINAIRE LUMENS	2049
TOTAL LUMINAIRE EFFICIENCY	60%
LUMINAIRE EFFECIENCY RATING	93
TOTAL LUMINAIRE WATTS	22

IES INDOOR REPORT

PHOTOMETRIC FILENAME : 941LURCL L7W6D 35K F05.IES

POLAR GRAPH

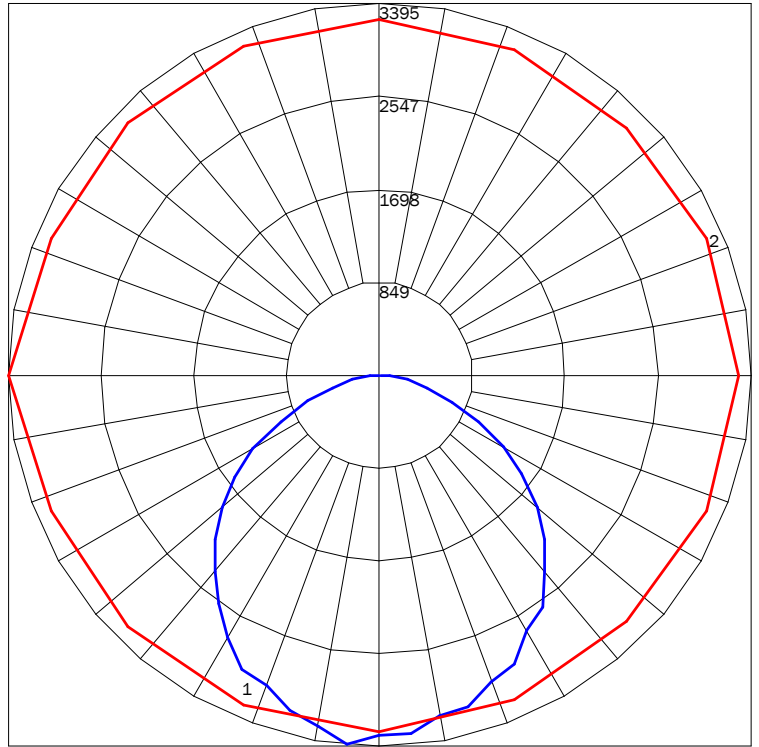

MAXIMUM CANDELA = 3395.47 LOCATED AT HORIZONTAL ANGLE = 180, VERTICAL ANGLE = 5
 # 1 - VERTICAL PLANE THROUGH HORIZONTAL ANGLES (180 - 0) (THROUGH MAX. CD.)
 # 2 - HORIZONTAL CONE THROUGH VERTICAL ANGLE (5) (THROUGH MAX. CD.)

LUMINAIRE LUMENS	8923
TOTAL LUMINAIRE EFFICIENCY	60%
LUMINAIRE EFFECIENCY RATING	93
TOTAL LUMINAIRE WATTS	96

AVAILABLE FINISHES



F04
MATTE
WHITE



F05
GLOSS
WHITE



F09
PEWTER



F15
MATTE
BLACK



F16
GLOSS
BLACK



F18
SATIN
ALUMINUM



F21
ARCH
BRONZE



F33
PYRITE
BRONZE



RAL
CUSTOM
COLOR
(RAL #)

NOTE: SOME OPTIONS MAY NOT BE COMPATIBLE WITH OTHERS. **ALL SPECIFICATIONS ARE SUBJECT TO CHANGE WITHOUT NOTICE.** CONTACT TMS LIGHTING FOR UPDATED SPECIFICATIONS.