

LUNA QUADRI™ PENDANT

PROJECT: _____

TYPE: _____

QUANTITY: _____



PN: 941LURP

APPLICATION	<ul style="list-style-type: none">• DIRECT OR INDIRECT/DIRECT PENDANTS• INDOOR RATED
DIMENSION	<ul style="list-style-type: none">• AVAILABLE IN 24"- 84" LENGTHS AND 12"- 72" WIDTHS• CUSTOM SIZES AVAILABLE
ILLUMINATION	<ul style="list-style-type: none">• LED 90CRI• 2049 - 17330 LUMENS
ELECTRICAL	<ul style="list-style-type: none">• 120 - 277V• 6KV SURGE SUPPRESSION STANDARD
DIFFUSERS	<ul style="list-style-type: none">• HIGH EFFICIENCY ACRYLIC
MOUNTING	<ul style="list-style-type: none">• 96" BLACK OR WHITE DROP CORD WITH AIRCRAFT CABLE
CONSTRUCTION	<ul style="list-style-type: none">• ALUMINUM
FINISHES	<ul style="list-style-type: none">• AVAILABLE IN SEVERAL TMS POLYESTER POWDER COATED FINISHES• CUSTOM RAL FINISHES AVAILABLE
DIMMING	<ul style="list-style-type: none">• 0-10V STANDARD
WEIGHT	<ul style="list-style-type: none">• 51 LBS MAXIMUM

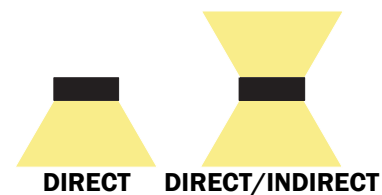

LUNA QUADRI™ PENDANT

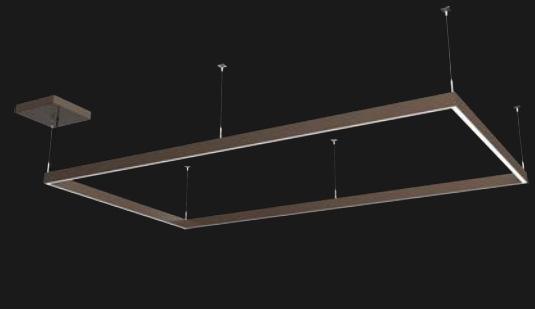

PROJECT: _____

TYPE: _____

QUANTITY: _____

941LURP -

1 2 3 4 5 6 7 8

1.	DIRECT										
PN	2L1WD	3L1WD	3L2WD	4L1WD	4L2WD	4L3WD	5L1WD	5L2WD	5L3WD	5L4WD	6L1WD
LxW	24X12	36X12	36X24	48X12	48X24	48X36	60X12	60X24	60X36	60X48	72X12
LED (W)	22	29	37	37	44	51	44	52	59	66	52
LUMENS	2049	2734	3423	3425	4117	4803	4115	4812	5508	6177	4810
PN	6L2WD	6L3WD	6L4WD	6L5WD	7L1WD	7L2WD	7L3WD	7L4WD	7L5WD	7L6WD	CUS
LxW	72X24	72X36	72X48	72X60	84X12	84X24	84X36	84X48	84X60	84X72	CUSTOM SIZE (SPECIFY LXW)
LED (W)	59	66	74	81	59	66	77	81	88	96	
LUMENS	5509	6173	6854	7548	5487	6200	6877	7551	8234	8923	
DIRECT/INDIRECT											
PN	2L1WID	3L1WID	3L2WID	4L1WID	4L2WID	4L3WID	5L1WID	5L2WID	5L3WID	5L4WID	6L1WID
LxW	24X12	36X12	36X24	48X12	48X24	48X36	60X12	60X24	60X36	60X48	72X12
LED (W)	44	59	74	71	88	103	88	103	118	132	103
LUMENS	3598	4968	6356	6362	7735	9108	7739	9108	10486	11861	9113
PN	6L2WID	6L3WID	6L4WID	6L5WID	7L1WID	7L2WID	7L3WID	7L4WID	7L5WID	7L6WID	CUS
LxW	72X24	72X36	72X48	72X60	84X12	84X24	84X36	84X48	84X60	84X72	CUSTOM SIZE (SPECIFY LXW)
LED (W)	118	132	147	162	117	132	147	162	177	191	
LUMENS	10479	11858	13248	14592	10491	11842	13248	14578	15960	17330	

2.	H	M	L	C: _____ ²
OUTPUT	100% LUMENS	75% LUMENS	50% LUMENS	[CUSTOM]% LUMENS

3.	30K	35K	40K
CCT	3000	3500	4000

4.	120	277	UNI
VOLTAGE	120V	277V	120V - 277V

5.	S	D
CIRCUIT	SINGLE	DUAL

6.	BC	WC
CORD	BLACK DROP CORD	WHITE DROP CORD

7.	F04	F05	F09	F15	F16	F18	F21	F31	F33	RAL
FINISH	MATTE WHITE	GLOSS WHITE	PEWTER	MATTE BLACK	GLOSS BLACK	SATIN ALUMINUM	ARCHITECTURAL BRONZE	SILVER METALLIC	PYRITE BRONZE	CUSTOM (SPECIFY)

8.	DIML	DIME
DIMMING	STANDARD 0-10V	LUTRON HI-LUME (1%)

NOTE: SOME OPTIONS MAY NOT BE COMPATIBLE WITH OTHERS. ALL SPECIFICATIONS ARE SUBJECT TO CHANGE WITHOUT NOTICE. CONTACT TMS LIGHTING FOR UPDATED SPECIFICATIONS.

LUNA QUADRI™ PENDANT

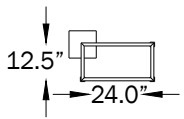

2L1W

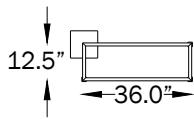

3L1W

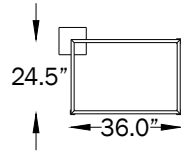

3L2W

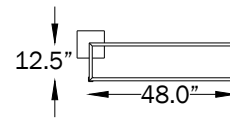

4L1W

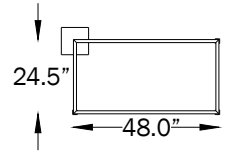

4L2W

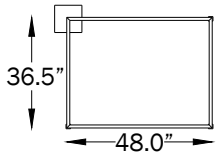

4L3W

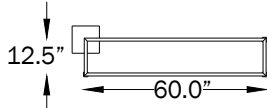

5L1W

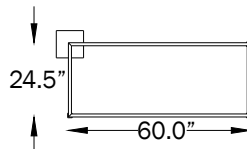

5L2W

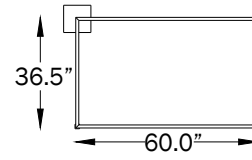

5L3W

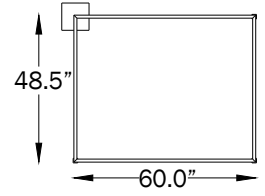

5L4W

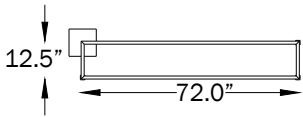

6L1W

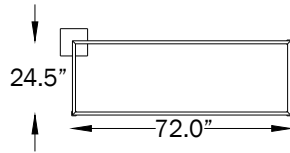

6L2W

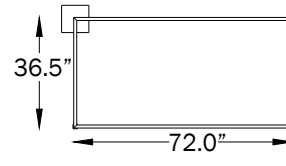

6L3W

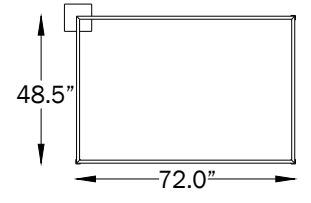

6L4W

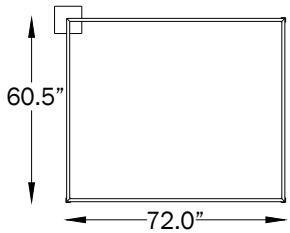

6L5W

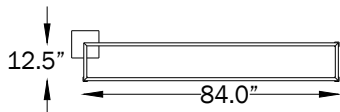

7L1W

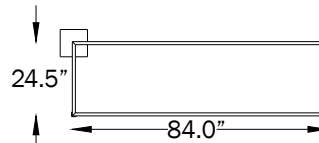

7L2W

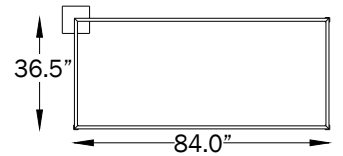

7L3W

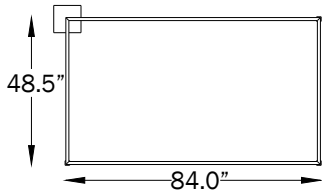

7L5W

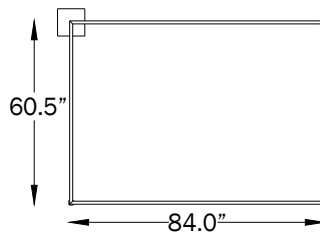

7L6W

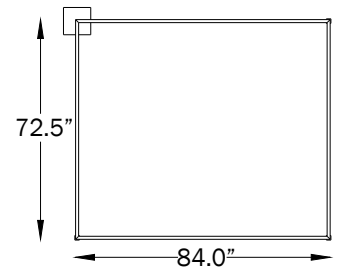

7L4W

LUNA QUADRI™ PENDANT

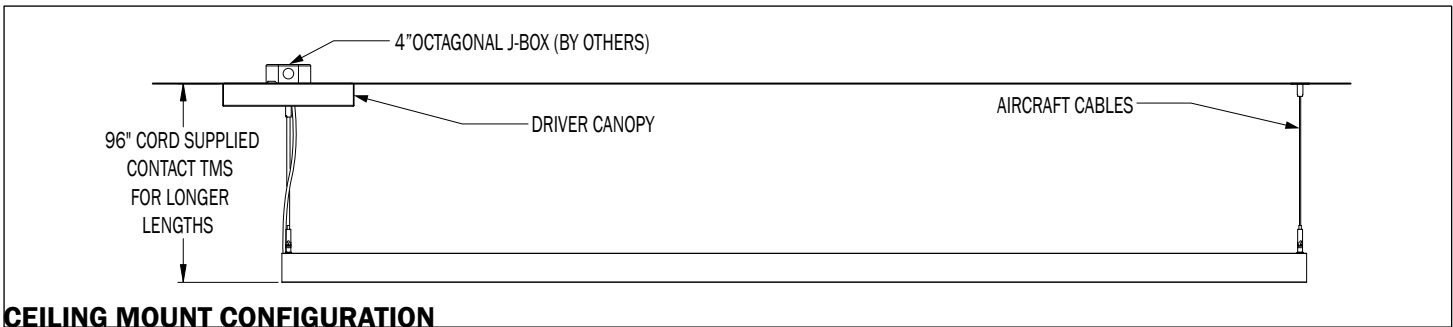
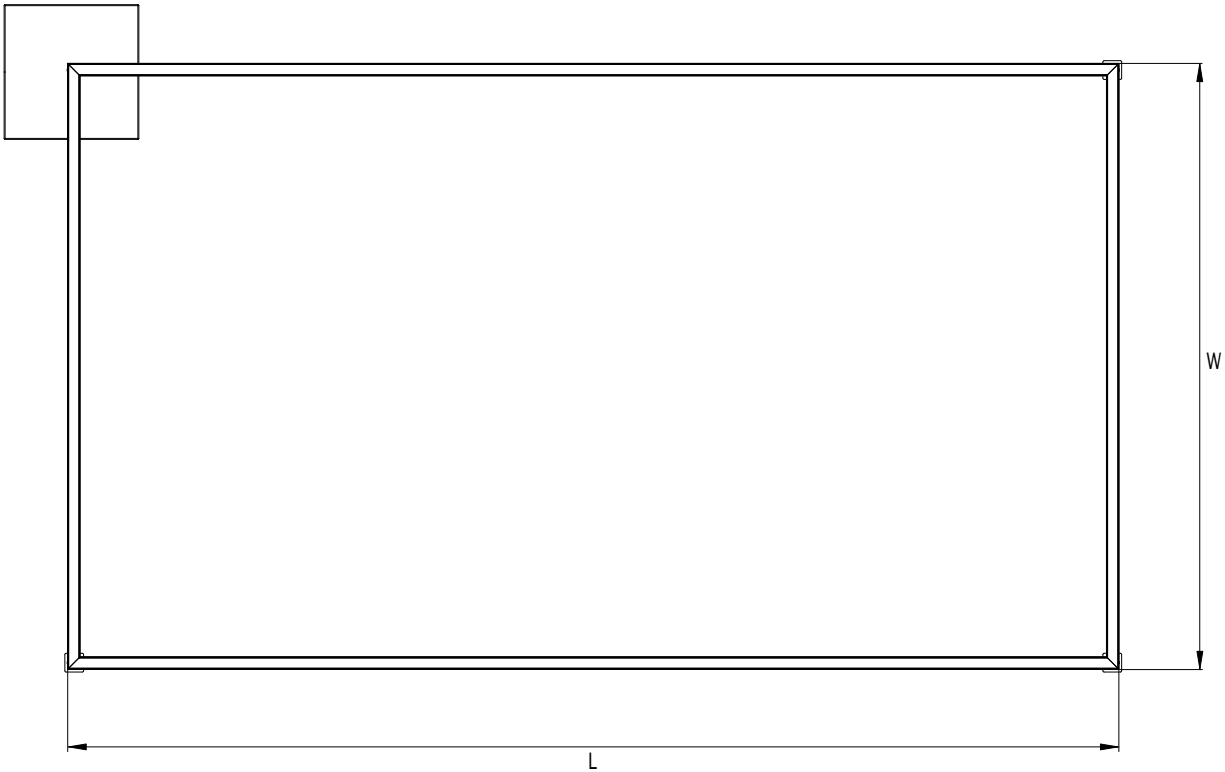

CEILING MOUNT CONFIGURATION

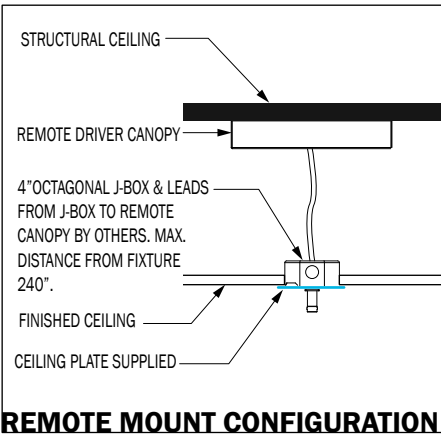

REMOTE MOUNT CONFIGURATION

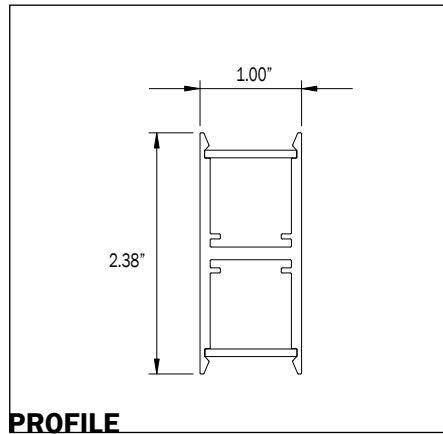

PROFILE

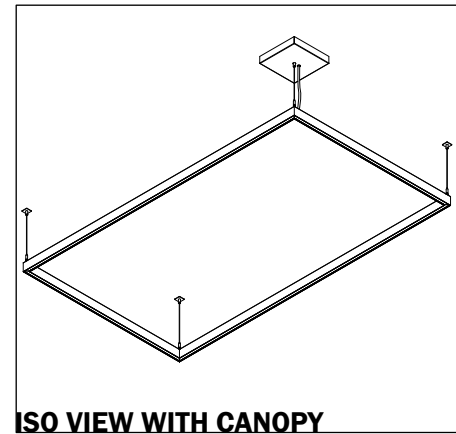

ISO VIEW WITH CANOPY

DIRECT

PN (INCH)	LUMENS	WATTAGE	CANOPY DIA	WEIGHT
2L1WD	2049	22	9"	13 LBS
3L1WD	2734	29	9"	15 LBS
3L2WD	3423	37	9"	17 LBS
4L1WD	3425	37	9"	22 LBS
4L2WD	4117	44	9"	24 LBS
4L3WD	4803	51	10"	26 LBS
5L1WD	4115	44	9"	25 LBS
5L2WD	4812	52	10"	27 LBS
5L3WD	5508	59	10"	33 LBS
5L4WD	6177	66	10"	39 LBS
6L1WD	4810	52	10"	28 LBS
6L2WD	5509	59	10"	30 LBS
6L3WD	6173	66	10"	36 LBS
6L4WD	6854	74	10"	42 LBS
6L5WD	7548	81	10"	45 LBS
7L1WD	5487	59	10"	45 LBS
7L2WD	6200	66	10"	31 LBS
7L3WD	6877	77	10"	35 LBS
7L4WD	7551	81	10"	40 LBS
7L5WD	8234	88	10"	48 LBS
7L6WD	8923	96	10"	51 LBS

INDIRECT

PN (INCH)	LUMENS	WATTAGE	CANOPY DIA	WEIGHT
2L1WID	3598	44	9"	13 LBS
3L1WID	4968	59	9"	15 LBS
3L2WID	6356	74	9"	17 LBS
4L1WID	6362	71	9"	22 LBS
4L2WID	7735	88	9"	24 LBS
4L3WID	9108	103	10"	26 LBS
5L1WID	7739	88	9"	25 LBS
5L2WID	9108	103	10"	27 LBS
5L3WID	10486	118	10"	33 LBS
5L4WID	11861	132	10"	39 LBS
6L1WID	9113	103	10"	28 LBS
6L2WID	10479	118	10"	30 LBS
6L3WID	11858	132	10"	36 LBS
6L4WID	13248	147	10"	42 LBS
6L5WID	14592	162	10"	45 LBS
7L1WID	10491	117	10"	45 LBS
7L2WID	11842	132	10"	31 LBS
7L3WID	13248	147	10"	35 LBS
7L4WID	14578	162	10"	40 LBS
7L5WID	15960	177	10"	48 LBS
7L6WID	17330	191	10"	51 LBS

LUNA QUADRI™ PENDANT

IES INDOOR REPORT

PHOTOMETRIC FILENAME : 941LURP L2W1D 35K F05.IES

POLAR GRAPH

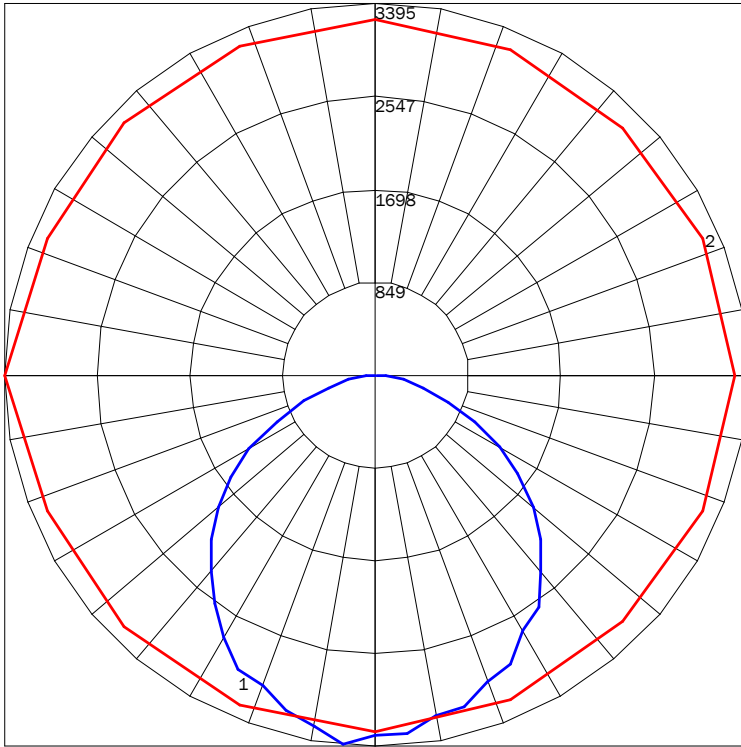

MAXIMUM CANDELA = 3395.47 LOCATED AT HORIZONTAL ANGLE = 180, VERTICAL ANGLE = 5
 # 1 - VERTICAL PLANE THROUGH HORIZONTAL ANGLES (180 - 0) (THROUGH MAX. CD.)
 # 2 - HORIZONTAL CONE THROUGH VERTICAL ANGLE (5) (THROUGH MAX. CD.)

LUMINAIRE LUMENS	8923
TOTAL LUMINAIRE EFFICIENCY	60%
LUMINAIRE EFFECIENCY RATING	93
TOTAL LUMINAIRE WATTS	22

IES INDOOR REPORT

PHOTOMETRIC FILENAME : 941LURP L7W6D 35K F05.IES

POLAR GRAPH

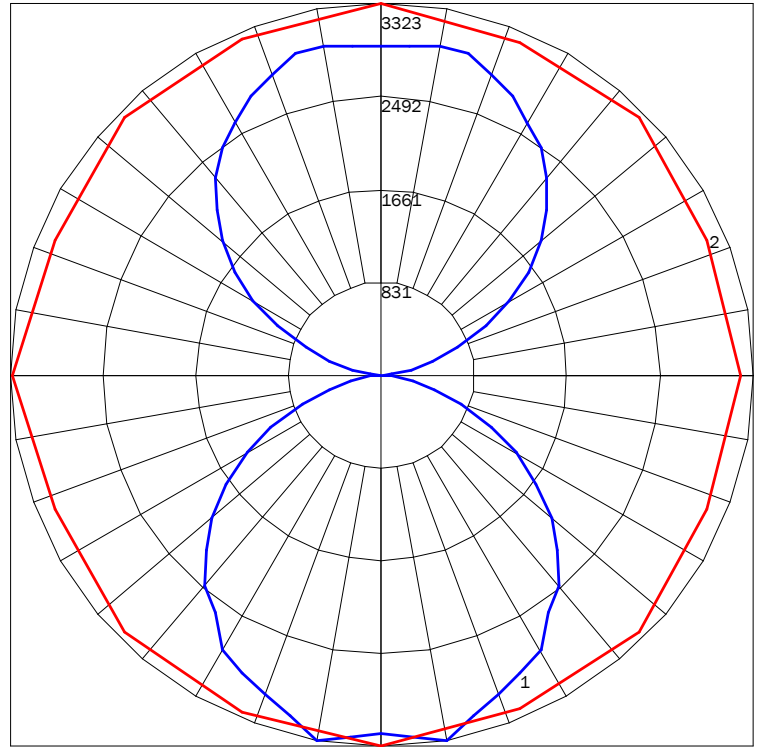

MAXIMUM CANDELA = 3322.7 LOCATED AT HORIZONTAL ANGLE = 90, VERTICAL ANGLE = 10
 # 1 - VERTICAL PLANE THROUGH HORIZONTAL ANGLES (90 - 270) (THROUGH MAX. CD.)
 # 2 - HORIZONTAL CONE THROUGH VERTICAL ANGLE (10) (THROUGH MAX. CD.)

LUMINAIRE LUMENS	17330
TOTAL LUMINAIRE EFFICIENCY	58%
LUMINAIRE EFFECIENCY RATING	91
TOTAL LUMINAIRE WATTS	191

LUNA QUADRI™ PENDANT

AVAILABLE FINISHES



F04
MATTE
WHITE



F05
GLOSS
WHITE



F09
PEWTER



F15
MATTE
BLACK



F16
GLOSS
BLACK



F18
SATIN
ALUMINUM



F21
ARCH
BRONZE



F31
SILVER
METALLIC



F33
PYRITE
BRONZE



RAL
CUSTOM
COLOR
(RAL #)

DISPLAYED FINISHES DIFFER BETWEEN SCREENS AS WELL AS PRINTERS AND MAY NOT ACCURATELY DEPICT COLOR.