

LUNA FUSO™ PENDANT

PROJECT: _____

TYPE: _____

QUANTITY: _____



PN: 871LU02

ILLUMINATION	<ul style="list-style-type: none"> • 5,675 - 21,208 LUMENS • DIRECT OR INDIRECT/DIRECT • LED 90CRI
APPLICATION	<ul style="list-style-type: none"> • DIRECT OR DIRECT/INDIRECT PENDANT MOUNT • INDOOR RATED
DIMENSION	<ul style="list-style-type: none"> • 24", 36", AND 48" SIZES (61cm, 91cm, AND 122cm) • PROFILE: 1"W X 2.625"H (2.54cm X 6.6675cm)
ELECTRICAL	<ul style="list-style-type: none"> • 120 - 277V • 10KV SURGE SUPPRESSION
DIFFUSERS	<ul style="list-style-type: none"> • HIGH EFFICIENCY ACRYLIC
MOUNTING	<ul style="list-style-type: none"> • 120" (304.8cm) BLACK OR WHITE DROP CORD WITH AIRCRAFT CABLES • 120" (304.8cm) POWER OVER SUSPENSION
LED DRIVER	<ul style="list-style-type: none"> • CANOPY OR REMOTE MOUNT
CONSTRUCTION	<ul style="list-style-type: none"> • ALUMINUM
FINISHES	<ul style="list-style-type: none"> • AVAILABLE IN SEVERAL TMS POWDER COATED FINISHES • CUSTOM RAL FINISHES AVAILABLE
DIMMING	<ul style="list-style-type: none"> • 0 - 10V (1%) DIMMING (120-277V) • LINE VOLTAGE/TRIAC/ELV (120V ONLY) • LUTRON HI-LUME (1%) DIMMING (120-277V)
WEIGHT	<ul style="list-style-type: none"> • 30 LBS MINIMUM, 56 LBS MAXIMUM

FLAT DIFFUSER

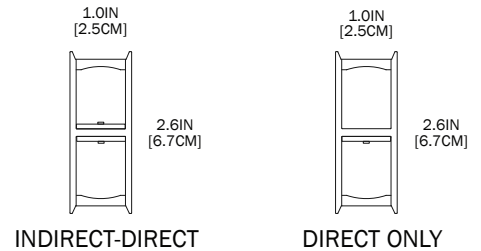

DOM DIFFUSER

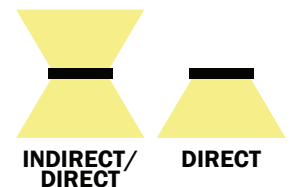
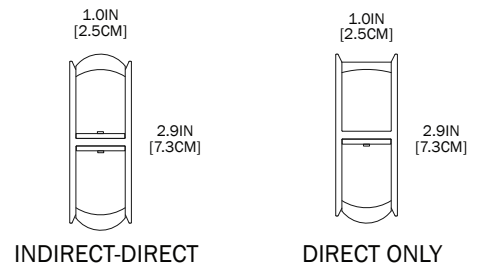

INDOOR



TMSLIGHTING

LUNA FUSO™ PENDANT

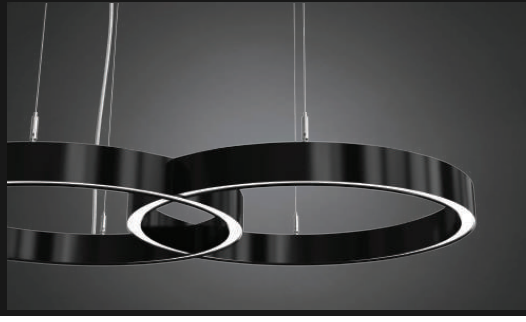

PROJECT: _____

TYPE: _____

QUANTITY: _____

871LU02

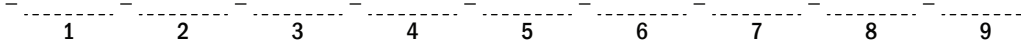

1.	DIRECT													
DIA (L X W)	24D		36D			48D								
	40" X 24"DIA (61CM)		64" X 36"DIA (91CM)			84" X 48"DIA (122CM)								
LED (W)	66		103			127								
LUMENS	5675		8909			10948								
	INDIRECT/DIRECT													
DIA (L X W)	24ID		36ID			48ID								
	40" X 24"DIA (61CM)		64" X 36"DIA (91CM)			84" X 48"DIA (122CM)								
LED (W)	132		206			253								
LUMENS	11060		17302			21208								
2.	H	M	L	C: _____ ²										
OUTPUT	100% LUMENS	75% LUMENS	50% LUMENS	[CUSTOM]% LUMENS										
3.	30K		35K			40K								
CCT	3000		3500			4000								
4.	S				D									
CIRCUITS	SINGLE				DUAL									
5.	MMCD				MMRM									
MOUNTING	MULTIPLE CABLES AND CANOPY DRIVER				MULTIPLE CABLES AND REMOTE DRIVER									
6.	BC		WC			POS								
CORD	BLACK DROP CORD WITH AIRCRAFT CABLES		WHITE DROP CORD WITH AIRCRAFT CABLES			POWER OVER SUSPENSION (SILVER ONLY) (UP TO 24" SIZE ONLY) (NOT APPLICABLE FOR MMCD COMBINATION)								
7.	FLAT				DOM									
DIFFUSER	FLAT DIFFUSER				DOME DIFFUSER									
8.	ADDITIONAL AND PREMIUM FINISHES AVAILABLE. SEE FINISHES CHART							F04	F05	F15	F16	F09	F31	F18
FINISH								MATTE WHITE	GLOSS WHITE	MATTE BLACK	GLOSS BLACK	PEWTER	SILVER METALLIC	SATIN ALUMINUM
9.	DIML		DIME				DIMV							
DIMMING	0-10V (1%) (120-277V)		LUTRON HI-LUME (1%) (120-277V) (UP TO 24" ONLY)				LINE VOLTAGE/TRIAC/ELV (120V ONLY)							

NOTE: SOME OPTIONS MAY NOT BE COMPATIBLE WITH OTHERS. ALL SPECIFICATIONS ARE SUBJECT TO CHANGE WITHOUT NOTICE. CONTACT TMS LIGHTING FOR UPDATED SPECIFICATIONS.

LUNA FUSO™ PENDANT

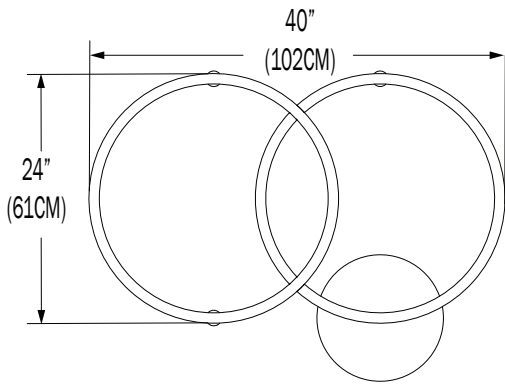

24D / 24ID

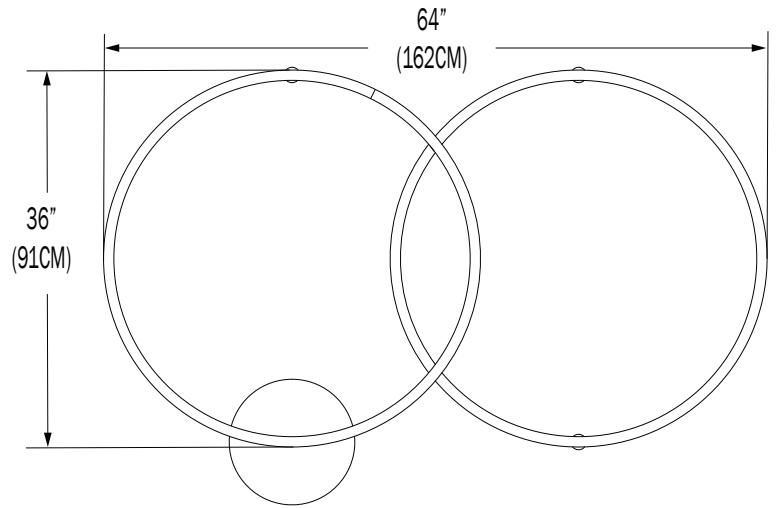

36D / 36ID

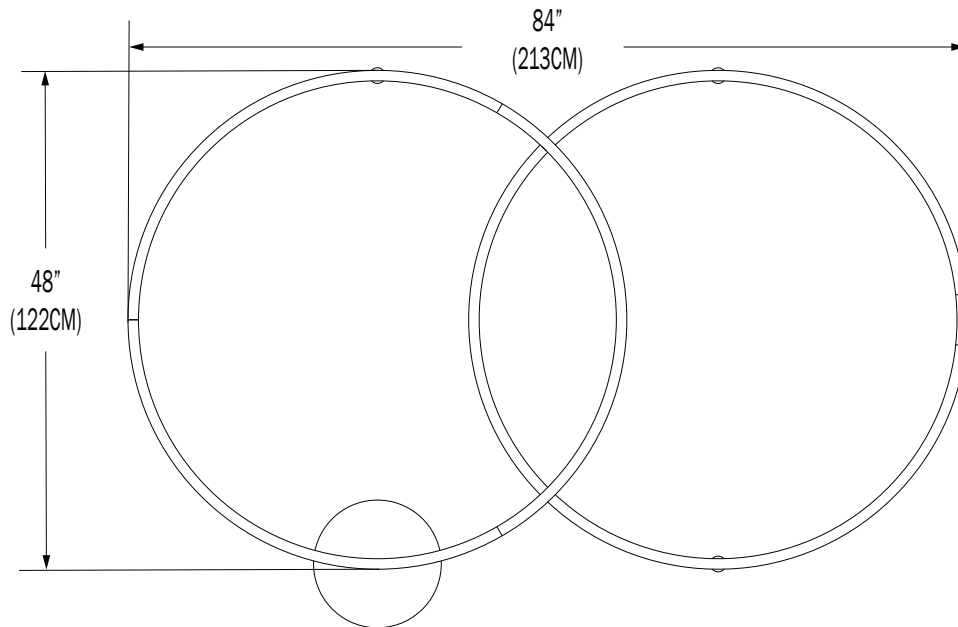

48D / 48ID

SIZE	ACTUAL SIZE	MOUNTING POINTS	CANOPY SIZE	NUMBER OF CANOPY	WEIGHT (POUNDS - LBS)	SECTIONS
24	24.5"	4	12"	1(D)/ 1(ID)	30	1
36	36.5"	4	12"	1(D)/ 1(ID)	40	1
48	47.5"	4	15"	1(D)/ 1(ID)	56	1

POS (POWER OVER SUSPENSION)

MMRM COMBINATION (MUTIPLE CABLES, REMOTE MOUNT DRIVER)

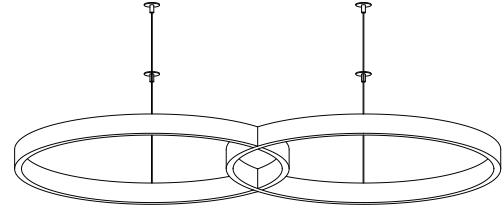
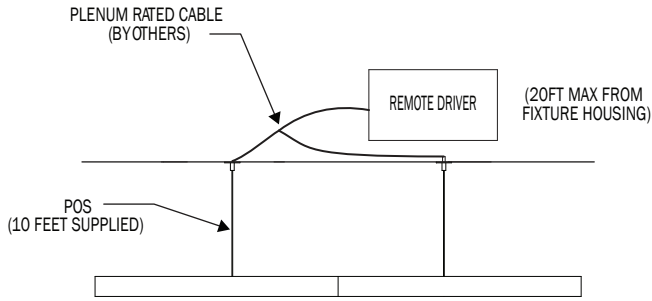

DROP CORD

MMCD COMBINATION (MUTIPLE CABLES, CANOPY MOUNT DRIVER)

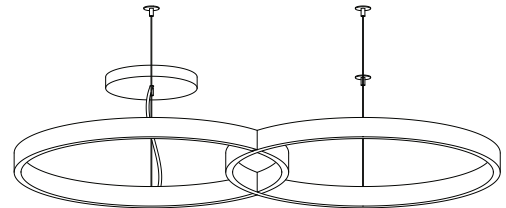
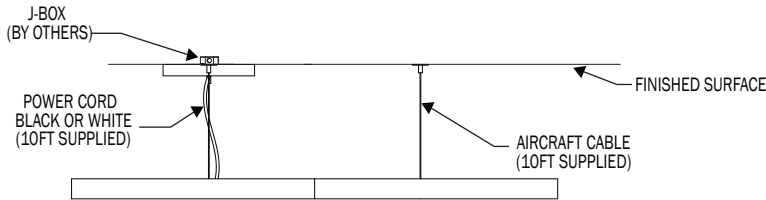

MMRM COMBINATION (MUTIPLE CABLES, REMOTE MOUNT DRIVER)

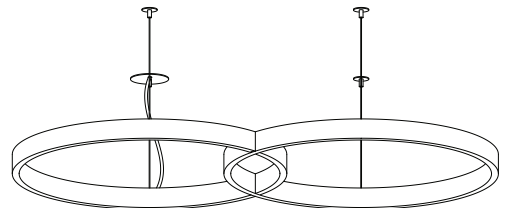
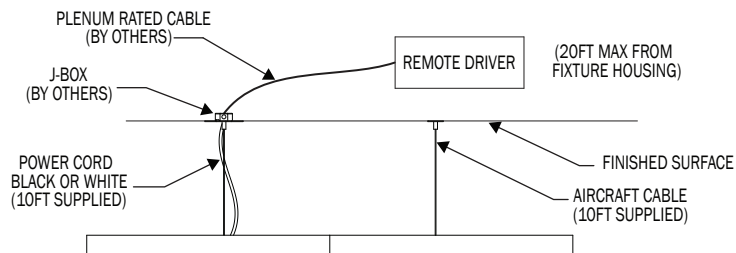

DIRECT

PN	SIZE (DIA)	LUMENS	WATTAGE
87LU02	24D	5675	66
	36D	8909	103
	48D	10948	127

IES INDOOR REPORT

PHOTOMETRIC FILENAME : 871LUO FUSE 48-48 D LED 35K F05

POLAR GRAPH

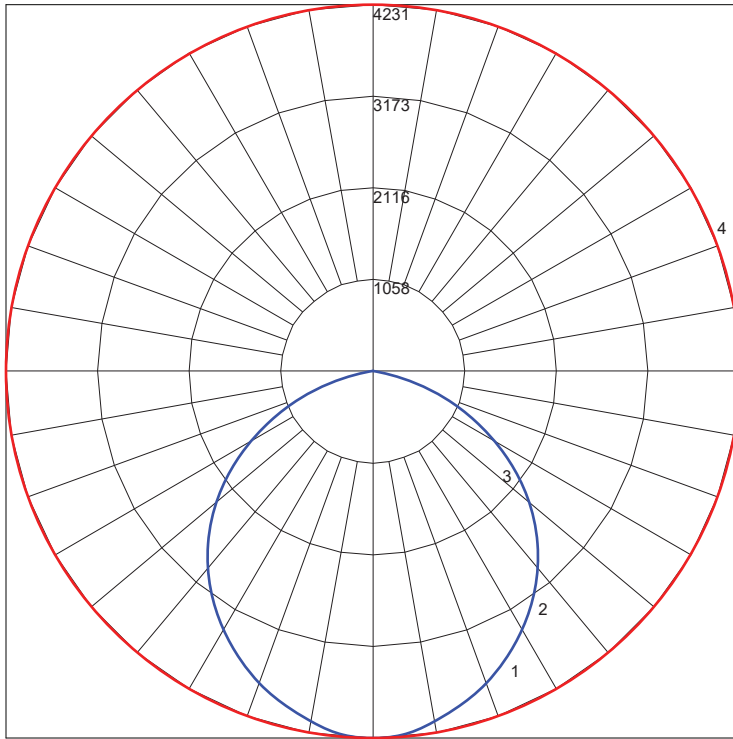

MAXIMUM CANDELA = 4231.16 LOCATED AT HORIZONTAL ANGLE = 0, VERTICAL ANGLE = 0
 # 1 - VERTICAL PLANE THROUGH HORIZONTAL ANGLES (0 - 180) (THROUGH MAX. CD.)
 # 2 - VERTICAL PLANE THROUGH HORIZONTAL ANGLES (45 - 225)
 # 3 - VERTICAL PLANE THROUGH HORIZONTAL ANGLES (90 - 270)
 # 4 - HORIZONTAL CONE THROUGH VERTICAL ANGLE (0) (THROUGH MAX. CD.)

LUMINAIRE LUMENS	10948
TOTAL LUMINAIRE EFFICIENCY	66%
LUMINAIRE EFFICACY RATING	86
TOTAL LUMINAIRE WATTS	127

INDIRECT / DIRECT

PN	SIZE (DIA)	LUMENS	WATTAGE
87LU02	24ID	11060	132
	36ID	17302	206
	48ID	21208	253

IES INDOOR REPORT

PHOTOMETRIC FILENAME : 871LUO FUSE 48-48 ID LED 35K F05

POLAR GRAPH

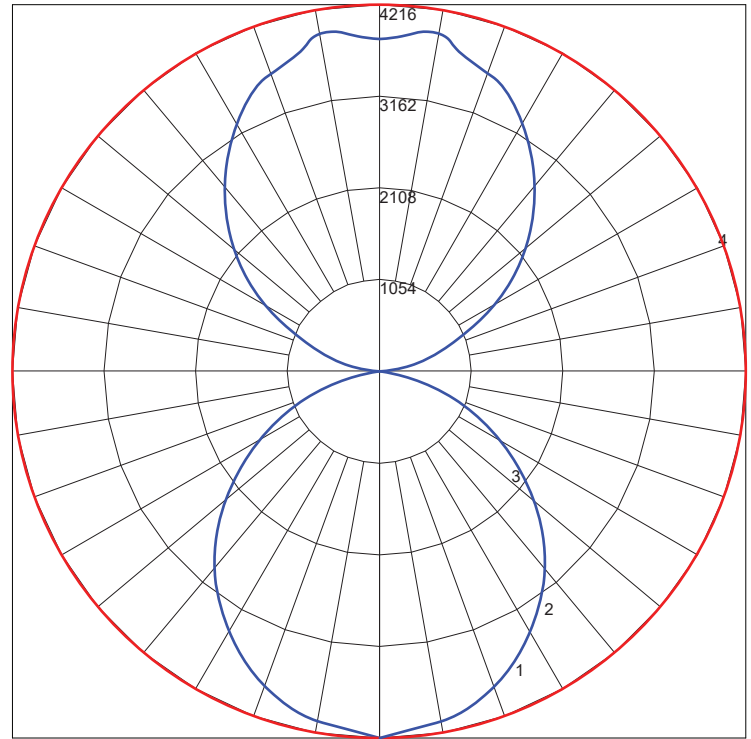

MAXIMUM CANDELA = 4216.03 LOCATED AT HORIZONTAL ANGLE = 0, VERTICAL ANGLE = 0
 # 1 - VERTICAL PLANE THROUGH HORIZONTAL ANGLES (0 - 180) (THROUGH MAX. CD.)
 # 2 - VERTICAL PLANE THROUGH HORIZONTAL ANGLES (45 - 225)
 # 3 - VERTICAL PLANE THROUGH HORIZONTAL ANGLES (90 - 270)
 # 4 - HORIZONTAL CONE THROUGH VERTICAL ANGLE (0) (THROUGH MAX. CD.)

LUMINAIRE LUMENS	21208
TOTAL LUMINAIRE EFFICIENCY	63%
LUMINAIRE EFFICACY RATING	84
TOTAL LUMINAIRE WATTS	253

LUNA FUSO™ PENDANT

FINISHES



PREMIUM FINISHES



NOTE: DISPLAYED FINISHES DIFFER BETWEEN SCREENS AS WELL AS PRINTERS AND MAY NOT ACCURATELY DEPICT COLOR.