

PROJECT: _____

TYPE: _____

QUANTITY: _____

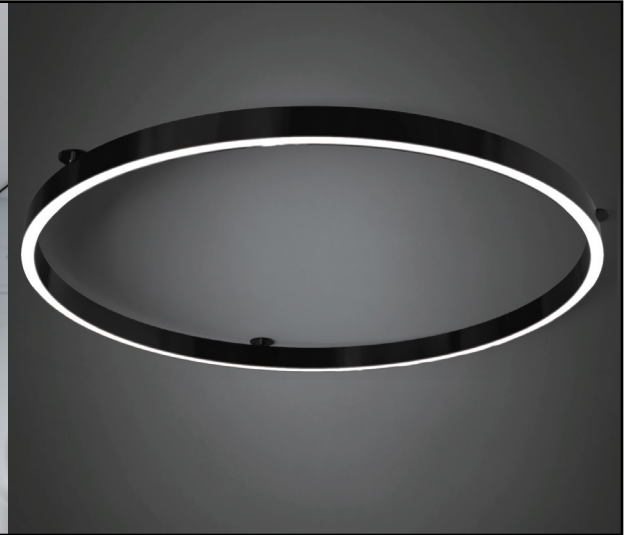

PN: 971LUCL

APPLICATION	<ul style="list-style-type: none"> • CEILING • INDOOR RATED
DIMENSION	<ul style="list-style-type: none"> • 24", 36", 48", 60", 72", 84" (61CM, 91CM, 122CM, 152CM, 183CM, 213CM) • PROFILE: 1" W X 2.38"H (2.5CM X 6CM)
ILLUMINATION	<ul style="list-style-type: none"> • DIRECT • LED 90CRI • 3,101 - 10,743 LUMENS
ELECTRICAL	<ul style="list-style-type: none"> • 120, 277V AND UNI (120 - 277V) • 10KA SURGE SUPPRESSION STANDARD
DIFFUSERS	<ul style="list-style-type: none"> • HIGH EFFICIENCY ACRYLIC
MOUNTING	<ul style="list-style-type: none"> • CANOPY OR REMOTE MOUNTED DRIVERS
CONSTRUCTION	<ul style="list-style-type: none"> • ALUMINUM
FINISHES	<ul style="list-style-type: none"> • AVAILABLE IN SEVERAL TMS POWDER COATED FINISHES • CUSTOM RAL FINISHES AVAILABLE
DIMMING	<ul style="list-style-type: none"> • 0 - 10V STANDARD DIMMING (1%) • LUTRON (1%) DIMMING OPTIONAL
WEIGHT	<ul style="list-style-type: none"> • 45 LBS MAXIMUM





PROJECT: _____
 TYPE: _____
 QUANTITY: _____

971LUCL 1 2 3 4 5 6 7

1.	24D	36D	48D	60D	72D	84D
DIAMETER	24" (61CM)	36" (91CM)	48" (122CM)	60" (152CM)	72" (183CM)	84" (213CM)
LED (W)	34W	51W	68W	85W	102W	118W
LUMENS	3101	4608	6158	7766	9270	10743

2.	H	M	L	C: _____ ¹
OUTPUT	100% LUMENS	75% LUMENS	50% LUMENS	[CUSTOM]% LUMENS

3.	30K	35K	40K
LED CCT	3000	3500	4000

4.	120	277	UNI
VOLTAGE	120V	277V	120 - 277V

5.	CD	RM
DRIVER	CANOPY MOUNT	REMOTE MOUNT

6.	F05	F09	F15	F16	F18	F19	F21	F31	F33	RAL
FINISH	WHITE	PEWTER	MATTE BLACK	GLOSS BLACK	SATIN ALUMINUM	MIRROR SILVER	ARCH BRONZE	SILVER METALLIC	PYRITE BRONZE	CUSTOM (SPECIFY)

7.	DIML	DIME ²
DIMMING	LED DIMMING (0 - 10V, CURRENT - SINKING)	LUTRON HI - LUME 1%

1. CUSTOM PERCENTAGE I.E. 60%. CONSULT FACTORY.
 2. DIAMETERS LARGER THAN 6FT (1.8M) ARE INCOMPATIBLE WITH LUTRON DIMMING

NOTE: SOME OPTIONS MAY NOT BE COMPATIBLE WITH OTHERS. ALL SPECIFICATIONS ARE SUBJECT TO CHANGE WITHOUT NOTICE. CONTACT TMS LIGHTING FOR UPDATED SPECIFICATIONS.

971LUCL

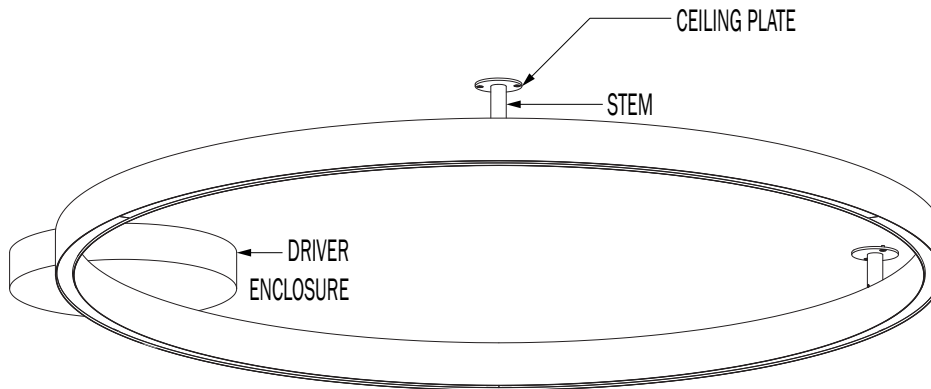

ISO VIEW CANOPY MOUNT

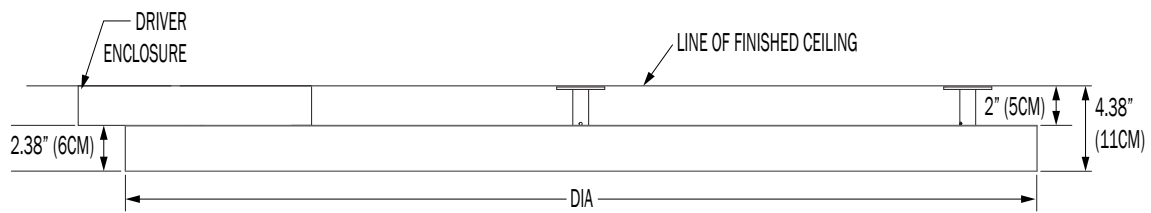

CD - CANOPY MOUNT

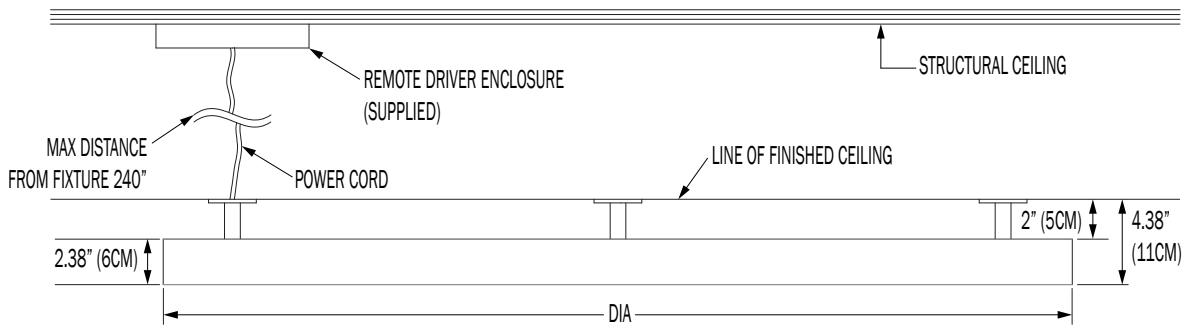

RM - REMOTE MOUNT

SIZE	SECTION	WEIGHT (LBS)
24" (61CM)	1	15
36" (91CM)	1	20
48" (122CM)	1	28
60" (152CM)	1	34
72" (183CM)	1	39
84" (213CM)	1	45

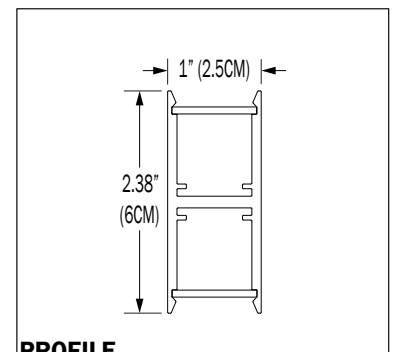

PROFILE

DIRECT

PN	SIZE (DIA)	LUMENS	WATTAGE
971LUCL	24D	3101	34
	36D	4608	51
	48D	6158	68
	60D	7766	85
	72D	9270	102
	84D	10743	118

IES INDOOR REPORT

PHOTOMETRIC FILENAME : 971LUCL 24D 35K F05.IES

POLAR GRAPH

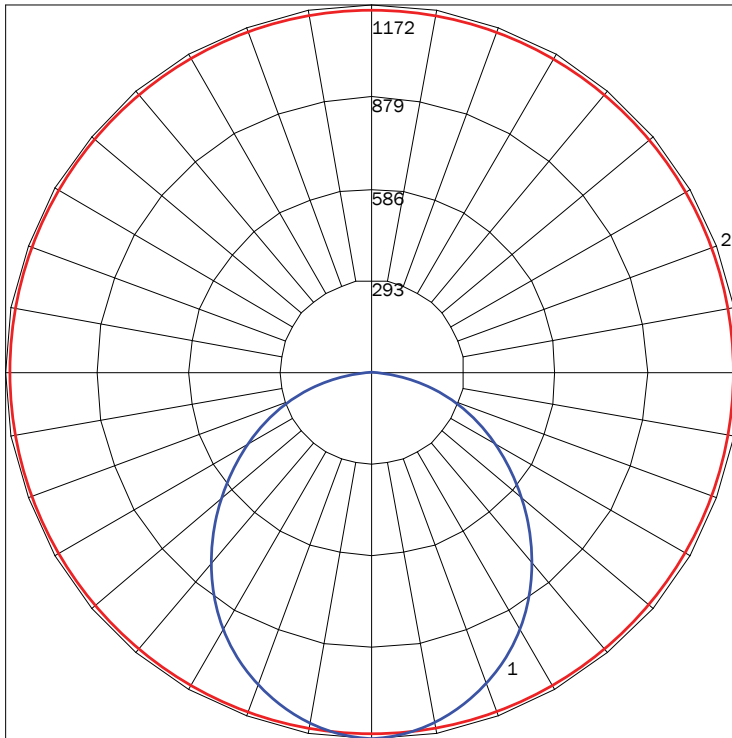

MAXIMUM CANDELA = 1172.49 LOCATED AT HORIZONTAL ANGLE = 0, VERTICAL ANGLE = 5
 # 1 - VERTICAL PLANE THROUGH HORIZONTAL ANGLES (0 - 180) (THROUGH MAX. CD.)
 # 2 - HORIZONTAL CONE THROUGH VERTICAL ANGLE (0) (THROUGH MAX. CD.)

LUMINAIRE LUMENS 3101
TOTAL LUMINAIRE EFFICIENCY 72%
LUMINAIRE EFFICACY RATING 92
TOTAL LUMINAIRE WATTS 34

IES INDOOR REPORT

PHOTOMETRIC FILENAME : 971LUCL 84D 35K F05.IES

POLAR GRAPH

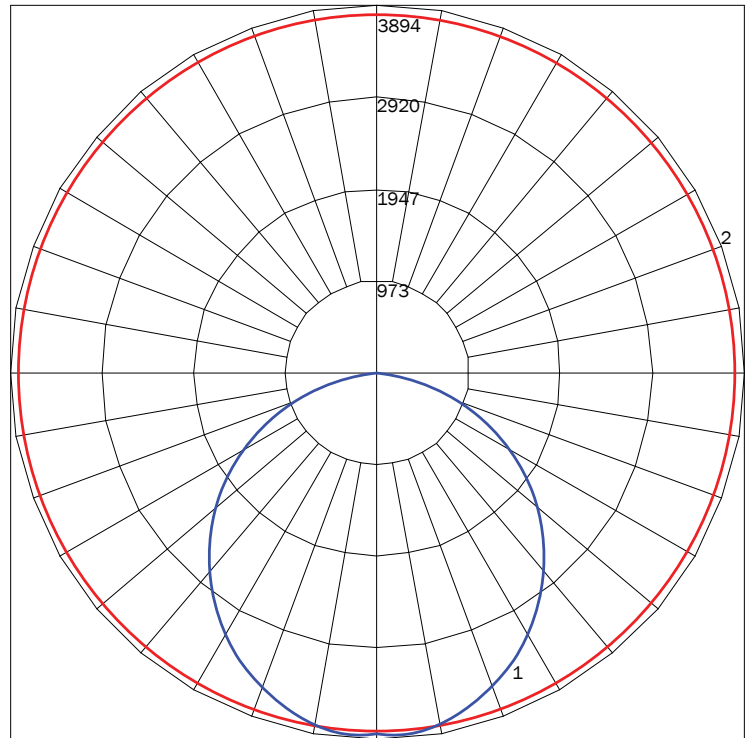

MAXIMUM CANDELA = 3893.9 LOCATED AT HORIZONTAL ANGLE = 90, VERTICAL ANGLE = 5
 # 1 - VERTICAL PLANE THROUGH HORIZONTAL ANGLES (90 - 270) (THROUGH MAX. CD.)
 # 2 - HORIZONTAL CONE THROUGH VERTICAL ANGLE (5) (THROUGH MAX. CD.)

LUMINAIRE LUMENS 10743
TOTAL LUMINAIRE EFFICIENCY 71%
LUMINAIRE EFFICACY RATING 91
TOTAL LUMINAIRE WATTS 118

AVAILABLE FINISHES



F05
GLOSS
WHITE



F09
PEWTER



F15
MATTE
BLACK



F16
GLOSS
BLACK



F18
SATIN
ALUMINUM



F19
MIRROR
SILVER



F21
ARCH
BRONZE



F31
SILVER
METALLIC



F33
PYRITE
BRONZE



RAL
CUSTOM
COLOR
(RAL #)

NOTE: DISPLAYED FINISHES DIFFER BETWEEN SCREENS AS WELL AS PRINTERS AND MAY NOT ACCURATELY DEPICT COLOR.