

ESPADA DOWN™ CYLINDER

PROJECT: _____

TYPE: _____

QUANTITY: _____

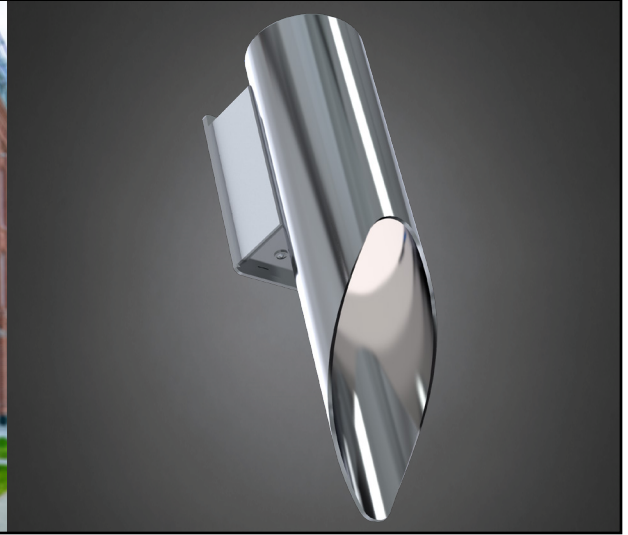

PN: ESPCYW

APPLICATION	<ul style="list-style-type: none">• WALL MOUNT• INDOOR OR OUTDOOR RATED
DIMENSION	<ul style="list-style-type: none">• 4" DIA X 17" (10CM X 44CM)
ILLUMINATION	<ul style="list-style-type: none">• INDIRECT/DIRECT• LED 90CRI• 797 - 982 LUMENS
ELECTRICAL	<ul style="list-style-type: none">• 120 - 277V (347V CONSULT FACTORY)• 10kA SURGE SUPPRESSION STANDARD
DIFFUSERS	<ul style="list-style-type: none">• HIGH EFFICIENCY ACRYLIC
MOUNTING	<ul style="list-style-type: none">• WALL, MOUNTED OVER A 2.4" X 4" SINGLE GANG J-BOX
CONSTRUCTION	<ul style="list-style-type: none">• ALUMINUM
FINISHES	<ul style="list-style-type: none">• AVAILABLE IN SEVERAL TMS POWDER COATED FINISHES• CUSTOM RAL FINISHES AVAILABLE
DIMMING	<ul style="list-style-type: none">• 0 - 10V STANDARD DIMMING
WEIGHT	<ul style="list-style-type: none">• 4.5 LBS MAXIMUM



TMSLIGHTING



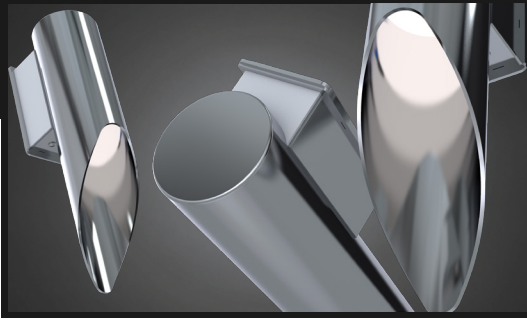

ESPADA DOWN™ CYLINDER

PROJECT: _____

TYPE: _____

QUANTITY: _____

ESPCYW - 1 - 2 - 3 - 4 - 5 - 6

1.	15LED					19LED				
ILLUMINATION	15W					19W				
LUMENS	797					982				
2.	30K			35K			40K			
LED CCT	3000K			3500K			4000K			
3.	120					277				
VOLTAGE	120V					277V				
4.	F05	F07	F08	F09	F10	F13	F14	F15	F16	F18
FINISH	WHITE	ZEUS BROWN	MIDNIGHT BLUE	PEWTER	FIRE RED	FOREST GREEN	SUNSHINE YELLOW	MATTE BLACK	GLOSS BLACK	SATIN ALUMINUM
	F19	F21	F24	F25	F26	F31	F32	F33	F34	RAL
	MIRROR SILVER	ARCH BRONZE	MELTED PLATINUM	MELTED GOLD	MELTED COPPER	SILVER METALLIC	BRONZE METALLIC	PYRITE BRONZE	BURNT ORANGE	CUSTOM (SPECIFY)
5.	---					DIML				
DIMMING	NONE					LED DIMMING (0 - 10V, CURRENT - SINKING)				
6.	---					EMR				
EMERGENCY ¹	NONE					REMOTE				

1. 10W AT 90 MINUTES

NOTE: SOME OPTIONS MAY NOT BE COMPATIBLE WITH OTHERS. ALL SPECIFICATIONS ARE SUBJECT TO CHANGE WITHOUT NOTICE. CONTACT TMS LIGHTING FOR UPDATED SPECIFICATIONS.

ESPADA DOWN™ CYLINDER

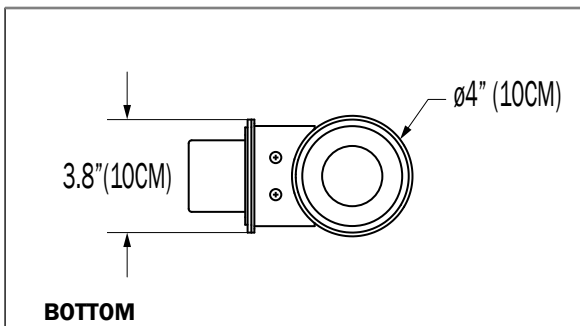
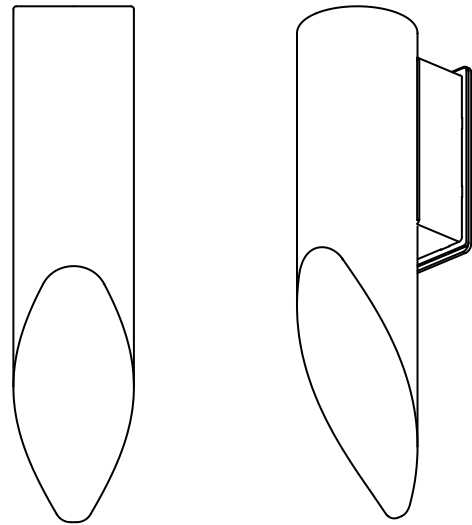
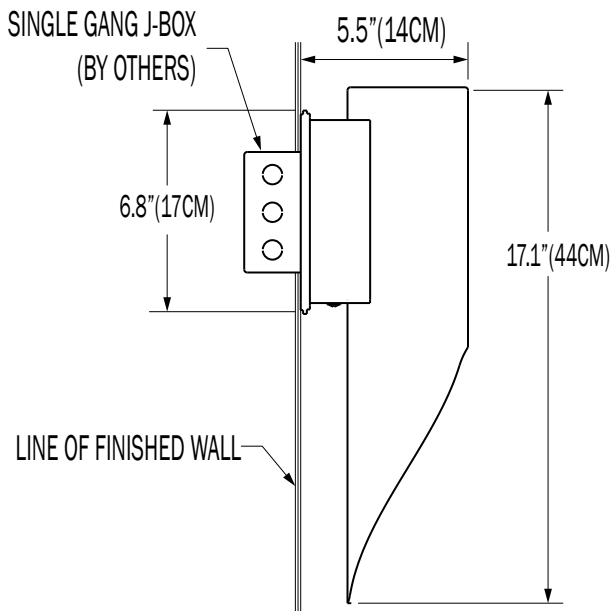

ESPADA DOWN™ CYLINDER

DIRECT

PN	ILLUMINATION	LUMENS
ESPCYW	15LED	797
	19LED	962

IES INDOOR REPORT

PHOTOMETRIC FILENAME : ESPCYW 15W 35K F05.IES

POLAR GRAPH

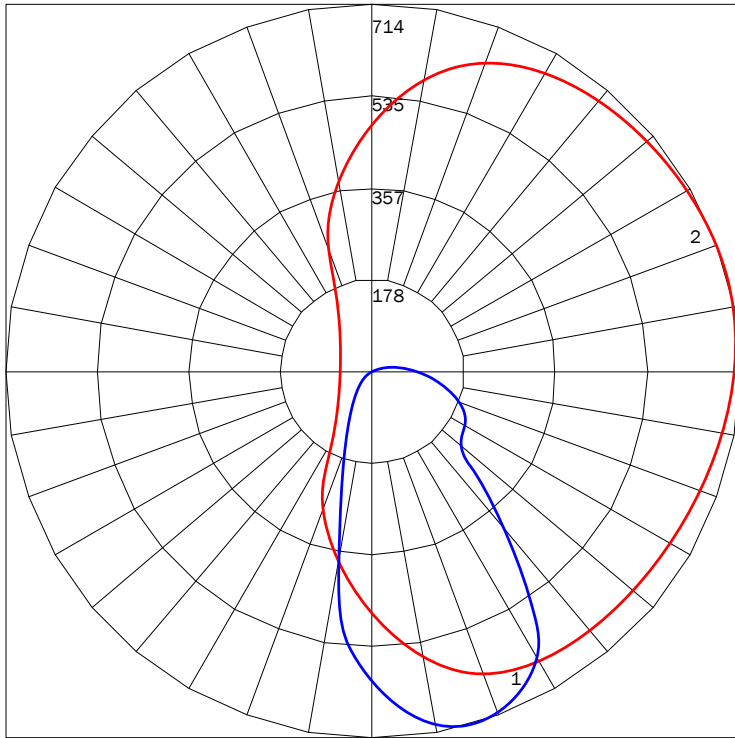

#1 Vertical Plane Through Horizontal Angles (15 - 195) (Through Max Cd.)
 #2 Horizontal Cone Through Vertical Angle (15) (Through Max Cd.)
 Maximum Candela = 713.78 Located At Horizontal Angle = 15, Vertical Angle = 15

LUMINAIRE LUMENS 797
TOTAL LUMINAIRE EFFICIENCY 54%
LUMINAIRE EFFECIENCY RATING 48
TOTAL LUMINAIRE WATTS 16.5

IES INDOOR REPORT

PHOTOMETRIC FILENAME : ESPCYW 19W 35K F05.IES

POLAR GRAPH

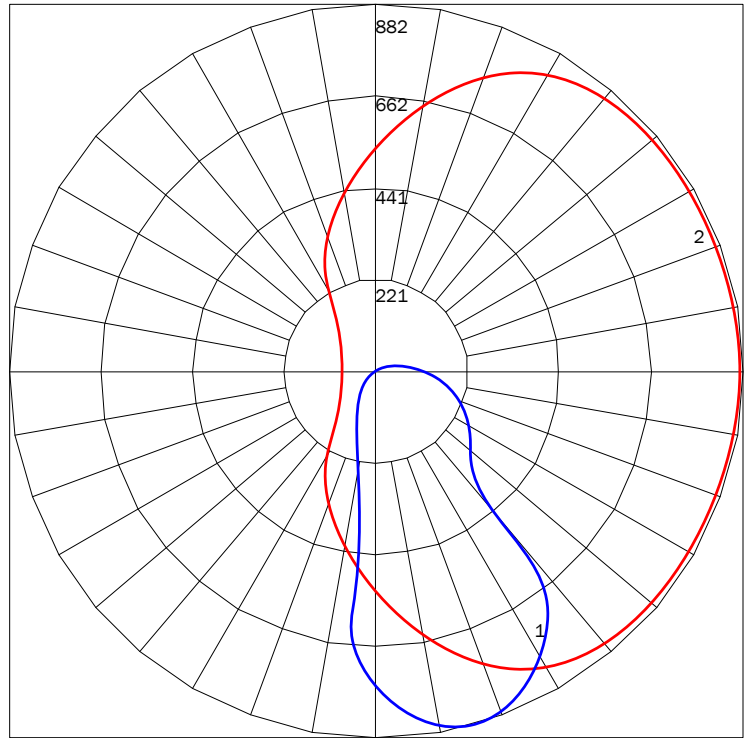

#1 Vertical Plane Through Horizontal Angles (0 - 180) (Through Max Cd.)
 #2 Horizontal Cone Through Vertical Angle (15) (Through Max Cd.)
 Maximum Candela = 882.17 Located At Horizontal Angle = 0, Vertical Angle = 15

LUMINAIRE LUMENS 962
TOTAL LUMINAIRE EFFICIENCY 54%
LUMINAIRE EFFECIENCY RATING 47
TOTAL LUMINAIRE WATTS 20.5

AVAILABLE FINISHES



F05
GLOSS
WHITE



F07
ZEUS
BROWN



F08
MIDNIGHT
BLUE



F09
PEWTER



F10
FIRE
RED



F13
FOREST
GREEN



F14
SUNSHINE
YELLOW



F15
MATTE
BLACK



F16
GLOSS
BLACK



F18
SATIN
ALUMINUM



F19
MIRROR
SILVER



F21
ARCH
BRONZE



F24
MELTED
PLATINUM



F25
MELTED
GOLD



F26
MELTED
COPPER



F31
SILVER
METALLIC



F32
METALLIC
BRONZE



F33
PYRITE
BRONZE



F34
BURNT
ORANGE



RAL
CUSTOM
COLOR
(RAL #)

NOTE: DISPLAYED FINISHES DIFFER BETWEEN SCREENS AS WELL AS PRINTERS AND MAY NOT ACCURATELY DEPICT COLOR.