

ENTICE™ PENDANT

PROJECT: _____

TYPE: _____

QUANTITY: _____



PN: 6045

ILLUMINATION	<ul style="list-style-type: none"> • 6,715 - 23,680 LUMENS • DIFFUSE • LED 90CRI
APPLICATION	<ul style="list-style-type: none"> • PENDANT MOUNT • RATED: INDOOR
DIMENSION	<ul style="list-style-type: none"> • 24", 36", 48", 60", 72" DIA. (61cm, 91cm, 122cm, 152cm, and 183cm) • PROFILE: 4.31"W X 2.75"H (11cm X 7cm)
ELECTRICAL	<ul style="list-style-type: none"> • 120 - 277V • 10KV SURGE SUPPRESSION
DIFFUSERS	<ul style="list-style-type: none"> • HIGH EFFICIENCY ACRYLIC
MOUNTING	<ul style="list-style-type: none"> • 120" (305cm) BLACK OR WHITE DROP CORD WITH AC CABLES • 120" POWER OVER SUSPENSION
LED DRIVER	<ul style="list-style-type: none"> • CANOPY OR REMOTE MOUNT
CONSTRUCTION	<ul style="list-style-type: none"> • ALUMINUM
FINISHES	<ul style="list-style-type: none"> • AVAILABLE IN SEVERAL TMS POWDER COATED FINISHES • CUSTOM RAL FINISHES AVAILABLE
DIMMING	<ul style="list-style-type: none"> • 0 - 10V DIMMING (120-277V) • LINE VOLTAGE/TRIAC/ELV (120V ONLY) • LUTRON DIMMING (120-277V)
WEIGHT	<ul style="list-style-type: none"> • 25 LBS MINIMUM, 45 LBS MAXIMUM

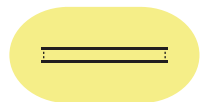
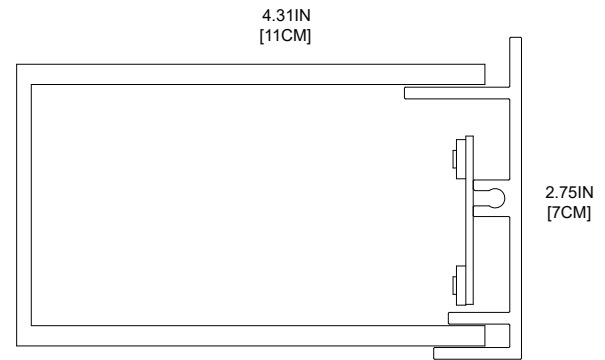

DIFFUSE

ENTICE™ PENDANT



PROJECT: _____

TYPE: _____

QUANTITY: _____

6045

1 2 3 4 5 6

1.	24	36	48	60	72				
DIAMETER	24"DIA. (61CM)	36"DIA. (91CM)	48"DIA. (122CM)	60"DIA. (152CM)	72"DIA. (183CM)				
LED (W)	65W	107W	147W	195W	240W				
LUMENS	6715	10380	14569	19341	23680				
2.	30K	35K	40K						
LED CCT	3000	3500	4000						
3.	MMCD	MMRM	PSCD	PSRM					
MOUNTING	MULTIPLE CABLES WITH CANOPY DRIVER	MULTIPLE CABLES WITH REMOTE DRIVER	SINGLE POINT WITH CANOPY DRIVER	SINGLE POINT WITH REMOTE DRIVER					
4.	BC	WC	POS						
CORD	BLACK DROP CORD WITH AIRCRAFT CABLES	WHITE DROP CORD WITH AIRCRAFT CABLES	POWER OVER SUSPENSION (SILVER ONLY) <small>(UP TO 60" ONLY) (NOT APPLICABLE FOR MMCD COMBINATION)</small>						
5.	ADDITIONAL AND PREMIUM FINISHES AVAILABLE. SEE FINISHES CHART		F04	F05	F15	F16	F09	F31	F18
FINISH			MATTE WHITE	GLOSS WHITE	MATTE BLACK	GLOSS BLACK	PEWTER	SILVER METALLIC	SATIN ALUMINUM
6.	DIML	DIME	DIMV						
DIMMING	0-10V (120-277V)	LUTRON HI-LUME (120-277V) <small>(UP TO 60" ONLY)</small>	LINE VOLTAGE/TRIAC/ELV (120V ONLY)						

NOTE: SOME OPTIONS MAY NOT BE COMPATIBLE WITH OTHERS. ALL SPECIFICATIONS ARE SUBJECT TO CHANGE WITHOUT NOTICE. CONTACT TMS LIGHTING FOR UPDATED SPECIFICATIONS.

ENTICE™ PENDANT

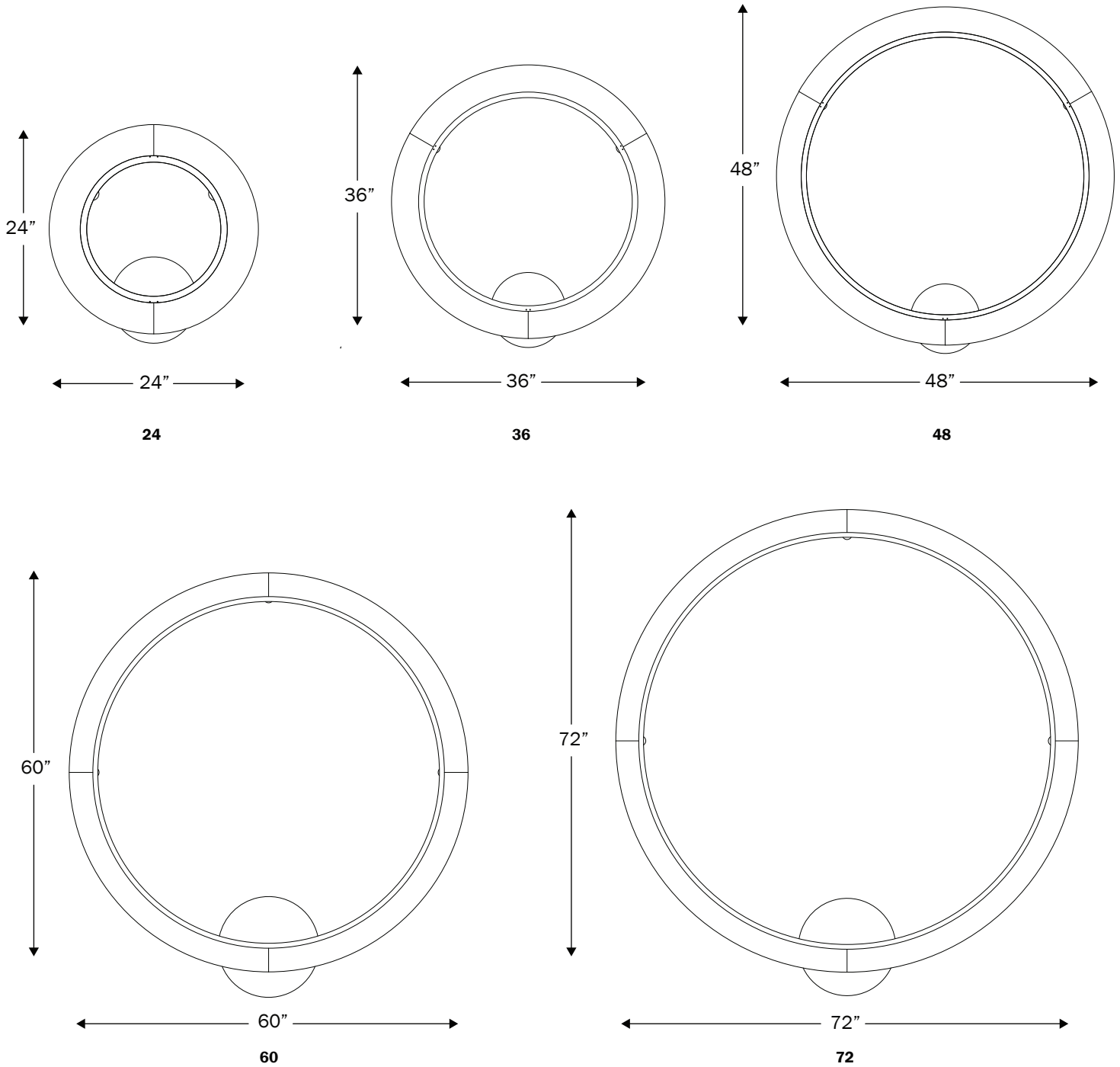

SIZES	DIAMETER	MOUNTING POINT	MINIMUM DISTANCE ^{1 2}	CANOPY SIZE		NUMBER OF CANOPY	WEIGHT (POUNDS - LBS)	SECTIONS
				MMCD	PSCD - PSRM			
24	24"	3	17"	10"	12"	1	25	1
36	36"	3	33"	10"	12"	1	30	1
48	48"	3	50"	10"	12"	1	35	1
60	60"	4	58"	15"	18"	1	40	1
72	72"	4	75"	15"	18"	1	45	1

1. ONLY FOR PS (SINGLE POINT) MOUNTING OPTION, THIS IS THE MINIMUM DISTANCE FROM CEILING TO THE BOTTOM OF THE FIXTURE
 2. MINIMUM CABLE MOUNTING ANGLE IS 70°

POS (POWER OVER SUSPENSION)

MMRM COMBINATION (MULTIPLE CABLES, REMOTE MOUNT DRIVER)

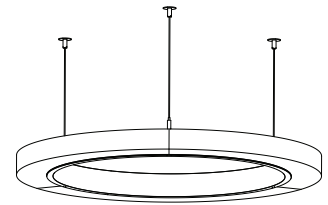
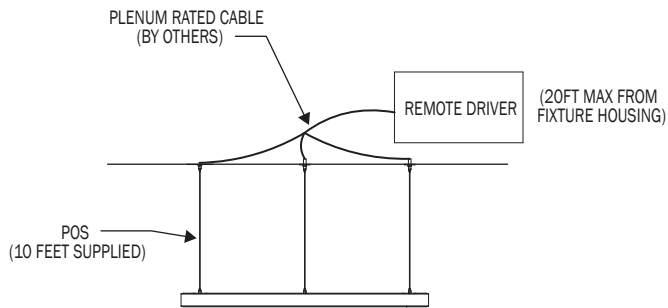

PSCD COMBINATION (SINGLE POINT, CANOPY MOUNT DRIVER)

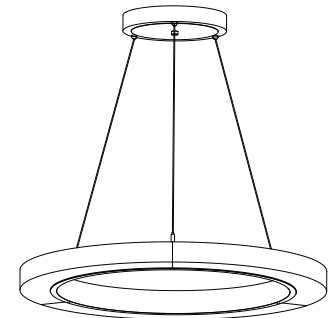
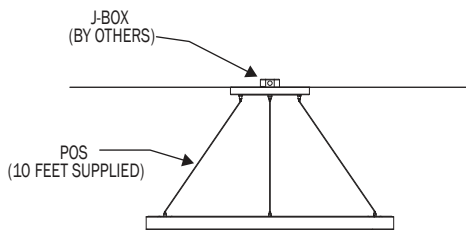

PSRM COMBINATION (SINGLE POINT, REMOTE MOUNT DRIVER)

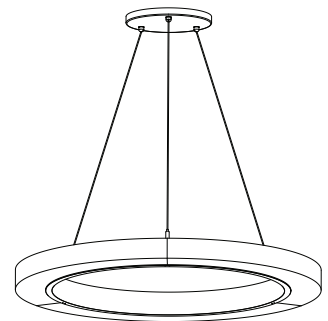
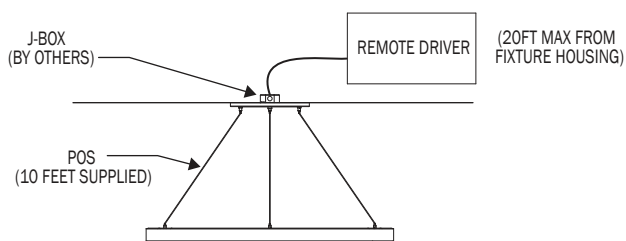

DROP CORD

MMCD COMBINATION (MUTIPLE CABLES, CANOPY MOUNT DRIVER)

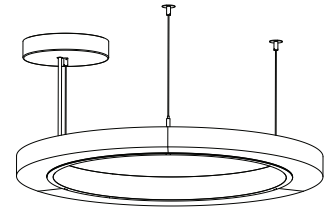
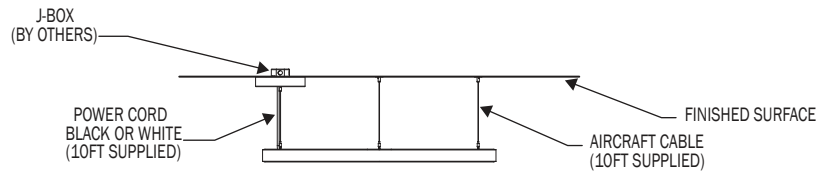

MMRM COMBINATION (MUTIPLE CABLES, REMOTE MOUNT DRIVER)

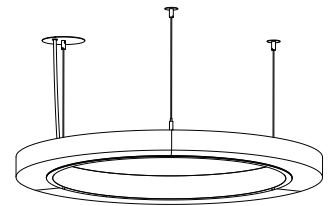
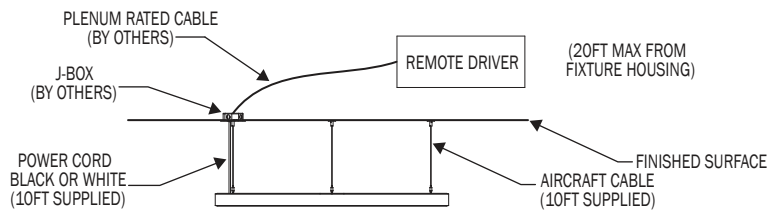

PSCD COMBINATION (SINGLE POINT, CANOPY MOUNT DRIVER)

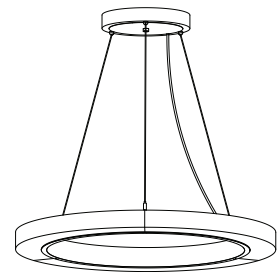
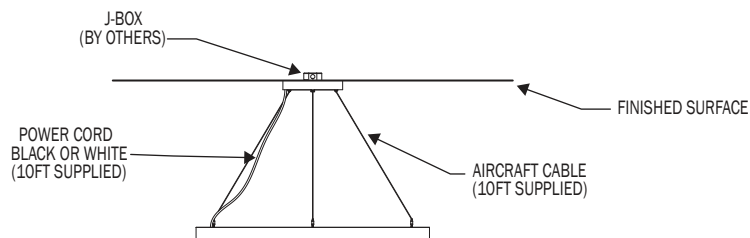

PSRM COMBINATION (SINGLE POINT, REMOTE MOUNT DRIVER)

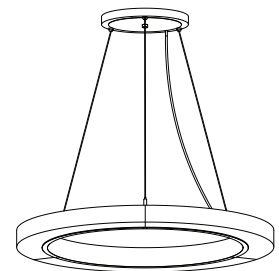
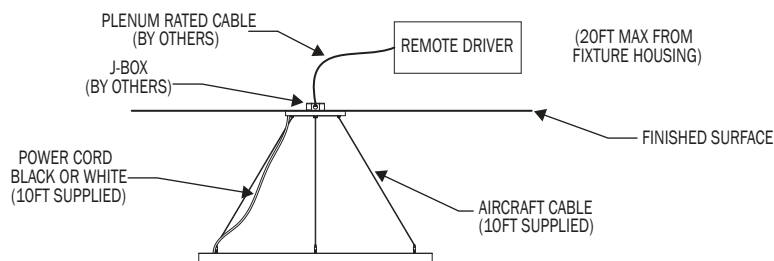

DIFFUSE

PN	SIZE (DIA)	LUMENS	WATTAGE
6045	24	6715	65
	36	10380	107
	48	14569	147
	60	19341	195
	72	23680	240

IES INDOOR REPORT

PHOTOMETRIC FILENAME : 6045 24 ID 35K F05.IES

POLAR GRAPH

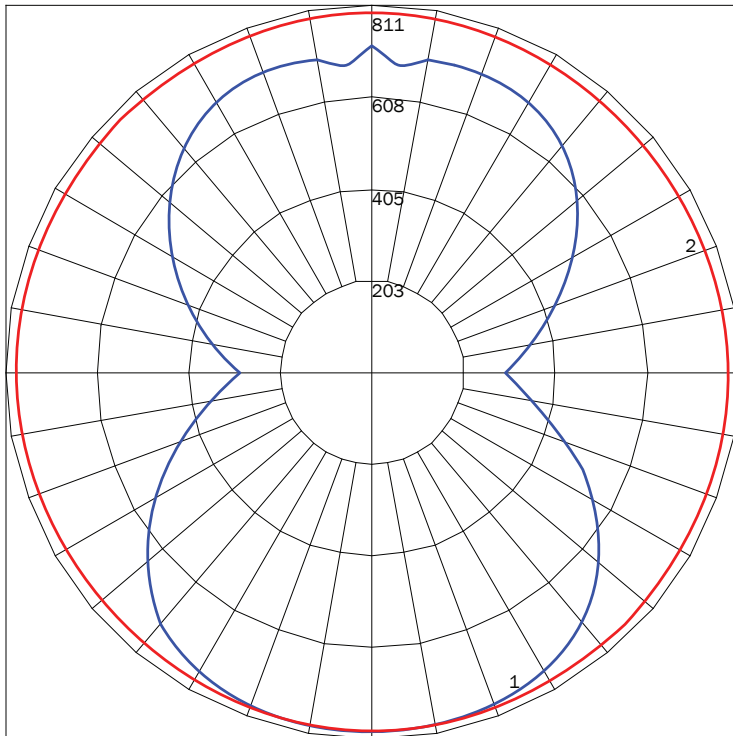

MAXIMUM CANDELA = 810.88 LOCATED AT HORIZONTAL ANGLE = 90, VERTICAL ANGLE = 15
 # 1 - VERTICAL PLANE THROUGH HORIZONTAL ANGLES (90 - 270) (THROUGH MAX. CD.)
 # 2 - HORIZONTAL CONE THROUGH VERTICAL ANGLE (15) (THROUGH MAX. CD.)

LUMINAIRE LUMENS 6715
TOTAL LUMINAIRE EFFICIENCY 81%
LUMINAIRE EFFICACY RATING 103
TOTAL LUMINAIRE WATTS 65

IES INDOOR REPORT

PHOTOMETRIC FILENAME : 6045 72 ID 35K F05.IES

POLAR GRAPH

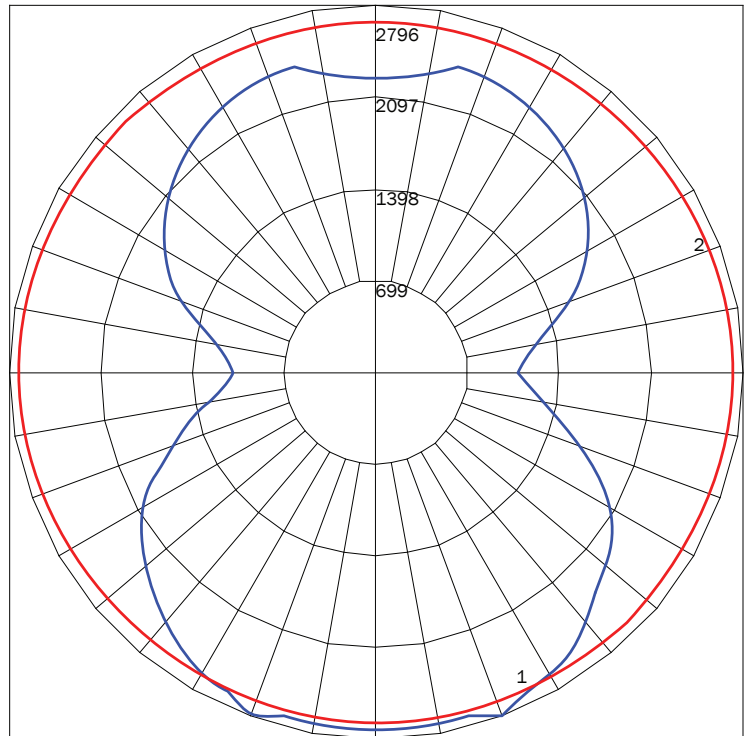

MAXIMUM CANDELA = 2795.82 LOCATED AT HORIZONTAL ANGLE = 0, VERTICAL ANGLE = 20
 # 1 - VERTICAL PLANE THROUGH HORIZONTAL ANGLES (0 - 180) (THROUGH MAX. CD.)
 # 2 - HORIZONTAL CONE THROUGH VERTICAL ANGLE (20) (THROUGH MAX. CD.)

LUMINAIRE LUMENS 23680
TOTAL LUMINAIRE EFFICIENCY 79%
LUMINAIRE EFFICACY RATING 99
TOTAL LUMINAIRE WATTS 240

FINISHES

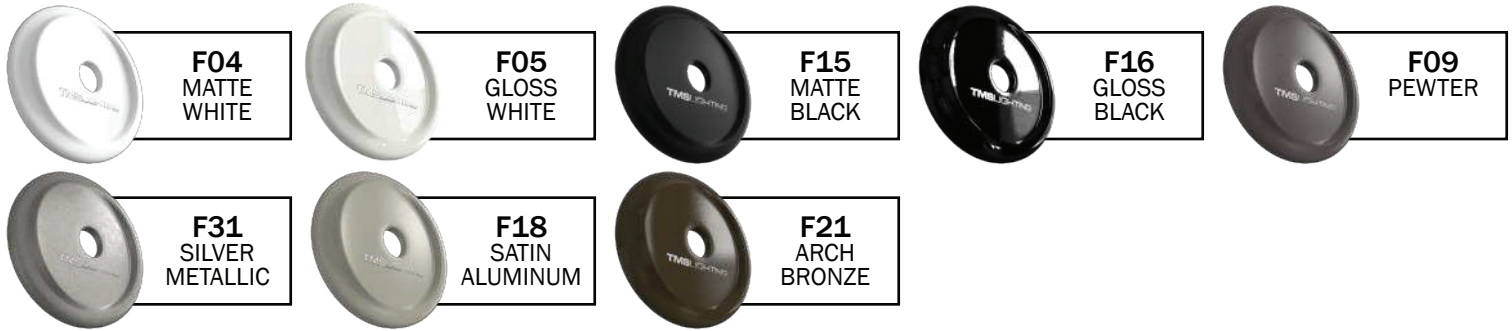

PREMIUM FINISHES



NOTE: DISPLAYED FINISHES DIFFER BETWEEN SCREENS AS WELL AS PRINTERS AND MAY NOT ACCURATELY DEPICT COLOR.