

ENTICE™ PENDANT

PROJECT: _____

TYPE: _____

QUANTITY: _____



PN: 6045

ILLUMINATION	<ul style="list-style-type: none"> • 6,715 - 23,680 LUMENS • DIFFUSE • LED 90CRI
APPLICATION	<ul style="list-style-type: none"> • PENDANT MOUNT • RATED: INDOOR
DIMENSION	<ul style="list-style-type: none"> • 24", 36", 48", 60", 72" DIA. (61cm, 91cm, 122cm, 152cm, and 183cm) • PROFILE: 4.31"W X 2.75"H (11cm X 7cm)
ELECTRICAL	<ul style="list-style-type: none"> • 120 - 277V • 10KV SURGE SUPPRESSION
DIFFUSERS	<ul style="list-style-type: none"> • HIGH EFFICIENCY ACRYLIC
MOUNTING	<ul style="list-style-type: none"> • 120" (305cm) BLACK OR WHITE DROP CORD WITH AC CABLES • 120" POWER OVER SUSPENSION
LED DRIVER	<ul style="list-style-type: none"> • CANOPY OR REMOTE MOUNT
CONSTRUCTION	<ul style="list-style-type: none"> • ALUMINUM
FINISHES	<ul style="list-style-type: none"> • AVAILABLE IN SEVERAL TMS POWDER COATED FINISHES • CUSTOM RAL FINISHES AVAILABLE
DIMMING	<ul style="list-style-type: none"> • 0 - 10V (1%) DIMMING (120-277V) • LINE VOLTAGE/TRIAC/ELV (120V ONLY) • LUTRON HI-LUME (1%) DIMMING (120-277V)
WEIGHT	<ul style="list-style-type: none"> • 25 LBS MINIMUM, 45 LBS MAXIMUM

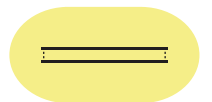
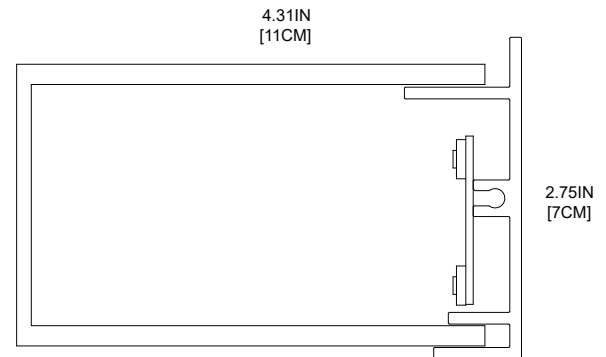

DIFFUSE

ENTICE™ PENDANT



PROJECT: _____
 TYPE: _____
 QUANTITY: _____

6045

1 2 3 4 5 6 7

1.	24	36	48	60	72
DIAMETER	24"DIA. (61CM)	36"DIA. (91CM)	48"DIA. (122CM)	60"DIA. (152CM)	72"DIA. (183CM)
LED (W)	65W	107W	147W	195W	240W
LUMENS	6715	10380	14569	19341	23680

2.	H	M	L	C: _____
OUTPUT	100% LUMENS	75% LUMENS	50% LUMENS	[CUSTOM]% LUMENS

3.	30K	35K	40K
LED CCT	3000	3500	4000

4.	MMCD	MMRM	PSCD	PSRM
MOUNTING	MULTIPLE CABLES WITH CANOPY DRIVER	MULTIPLE CABLES WITH REMOTE DRIVER	SINGLE POINT WITH CANOPY DRIVER	SINGLE POINT WITH REMOTE DRIVER

5.	BC	WC	POS
CORD	BLACK DROP CORD WITH AIRCRAFT CABLES	WHITE DROP CORD WITH AIRCRAFT CABLES	POWER OVER SUSPENSION (SILVER ONLY) <small>(UP TO 60" ONLY)</small> <small>(NOT APPLICABLE FOR MMCD COMBINATION)</small>

6.	ADDITIONAL AND PREMIUM FINISHES AVAILABLE. SEE FINISHES CHART							
FINISH	F04	F05	F15	F16	F09	F31	F18	
	MATTE WHITE	GLOSS WHITE	MATTE BLACK	GLOSS BLACK	PEWTER	SILVER METALLIC	SATIN ALUMINUM	

7.	DIML	DIME	DIMV
DIMMING	0-10V (1%) (120-277V)	LUTRON HI-LUME (1%) (120-277V) <small>(UP TO 48" ONLY)</small>	LINE VOLTAGE/TRIAC/ELV (120V ONLY)

NOTE: SOME OPTIONS MAY NOT BE COMPATIBLE WITH OTHERS. ALL SPECIFICATIONS ARE SUBJECT TO CHANGE WITHOUT NOTICE. CONTACT TMS LIGHTING FOR UPDATED SPECIFICATIONS.

ENTICE™ PENDANT

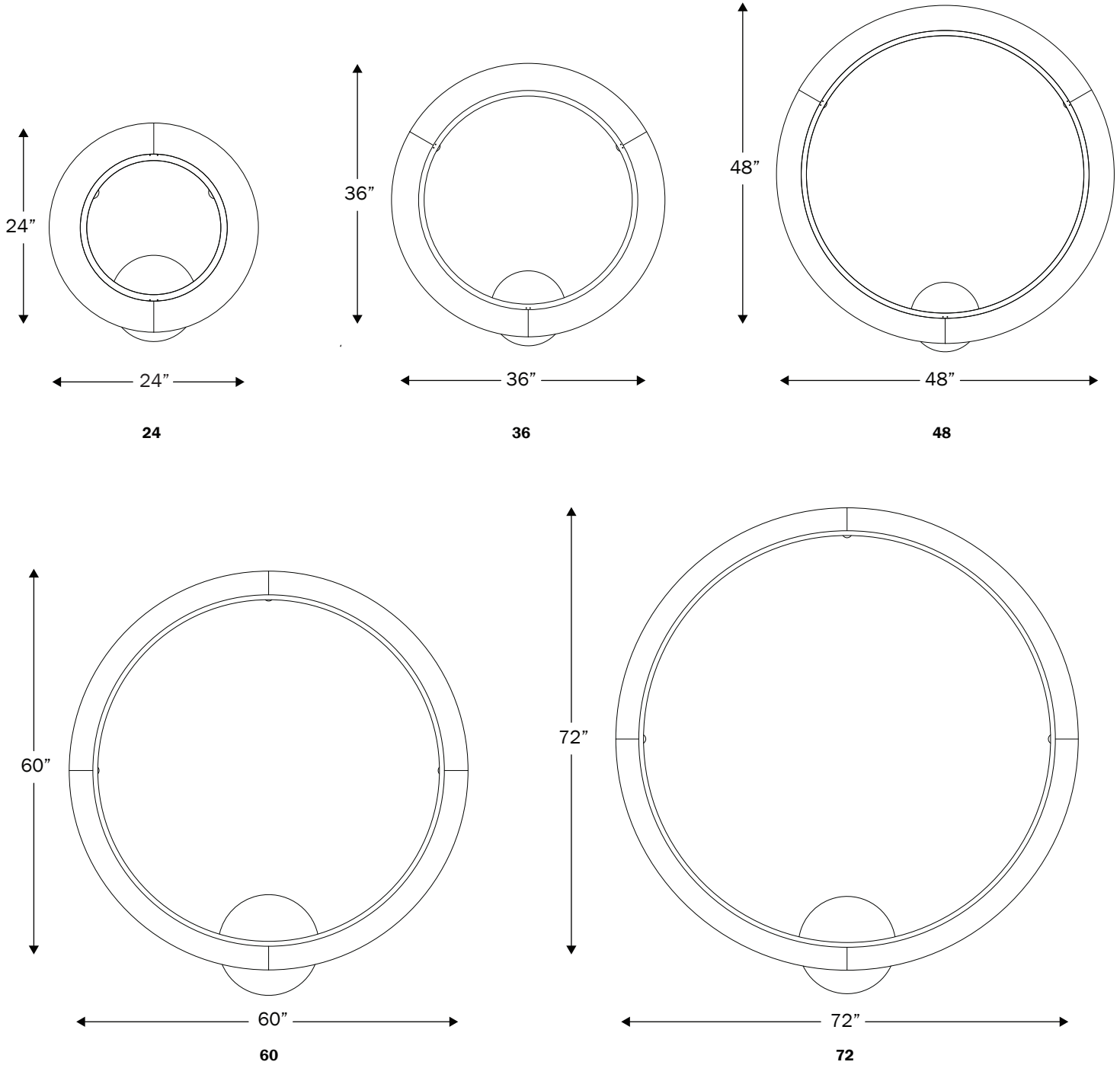

SIZES	DIAMETER	MOUNTING POINT	MINIMUM DISTANCE ^{1 2}	CANOPY SIZE		NUMBER OF CANOPY	WEIGHT (POUNDS - LBS)	SECTIONS
				MMCD	PSCD - PSRM			
24	24"	3	17"	10"	12"	1	25	1
36	36"	3	33"	10"	12"	1	30	1
48	48"	3	50"	10"	12"	1	35	1
60	60"	4	58"	15"	18"	1	40	1
72	72"	4	75"	15"	18"	1	45	1

1. ONLY FOR PS (SINGLE POINT) MOUNTING OPTION, THIS IS THE MINIMUM DISTANCE FROM CEILING TO THE BOTTOM OF THE FIXTURE
 2. MINIMUM CABLE MOUNTING ANGLE IS 70°

POS (POWER OVER SUSPENSION)

MMRM COMBINATION (MUTIPLE CABLES, REMOTE MOUNT DRIVER)

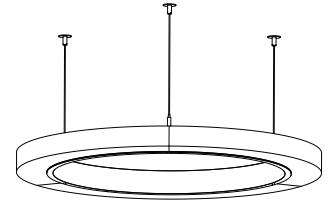
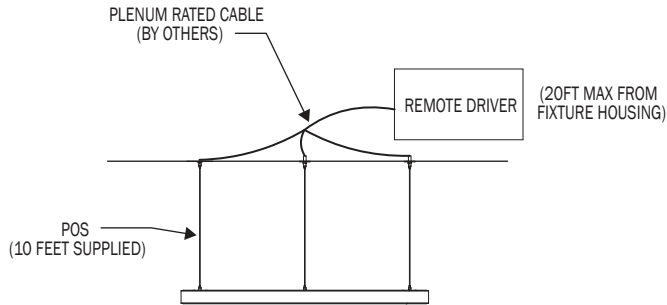

PSCD COMBINATION (SINGLE POINT, CANOPY MOUNT DRIVER)

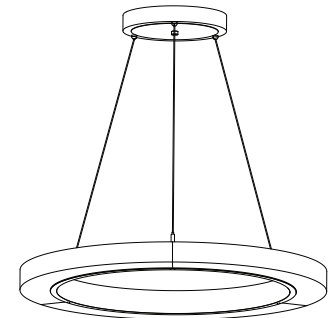
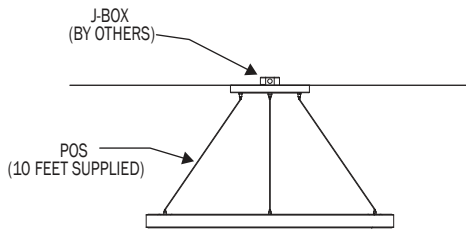

PSRM COMBINATION (SINGLE POINT, REMOTE MOUNT DRIVER)

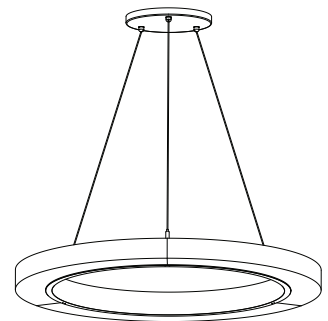
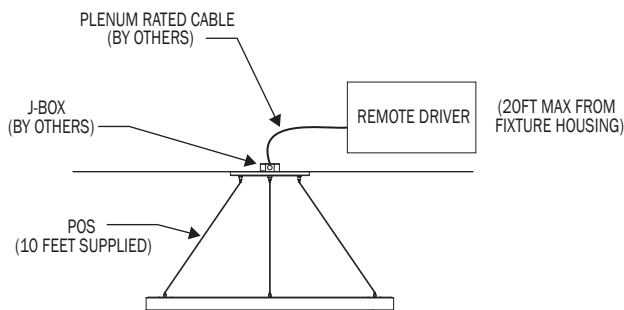

DROP CORD

MMCD COMBINATION (MUTIPLE CABLES, CANOPY MOUNT DRIVER)

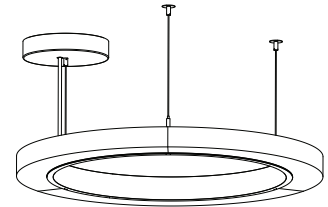
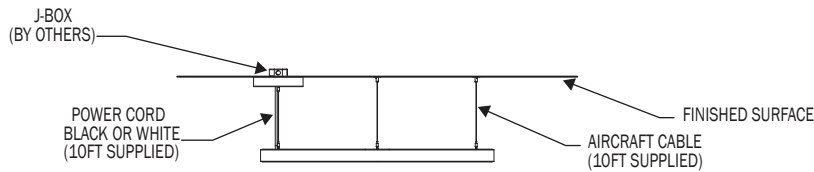

MMRM COMBINATION (MUTIPLE CABLES, REMOTE MOUNT DRIVER)

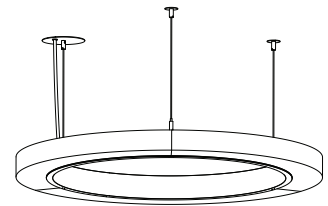
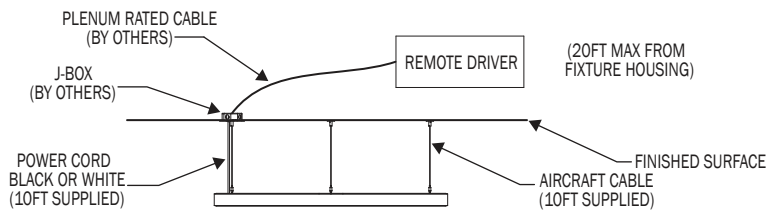

PSCD COMBINATION (SINGLE POINT, CANOPY MOUNT DRIVER)

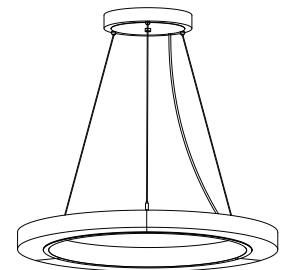
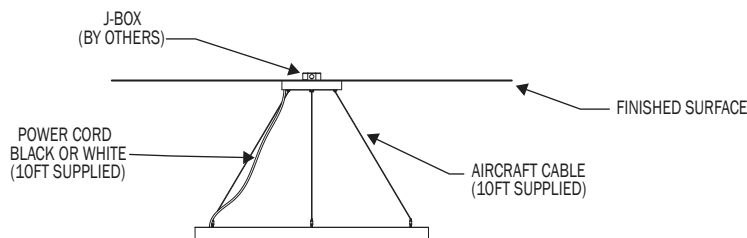

PSRM COMBINATION (SINGLE POINT, REMOTE MOUNT DRIVER)

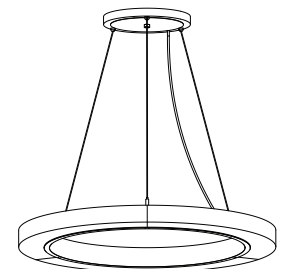
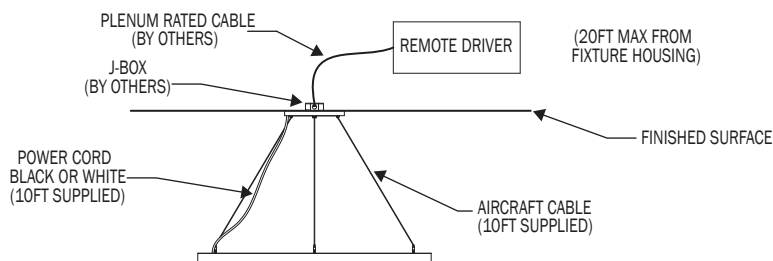

DIFFUSE

PN	SIZE (DIA)	LUMENS	WATTAGE
3250DI	24	6715	65
	36	10380	107
	48	14569	147
	60	19341	195
	72	23680	240

IES INDOOR REPORT

PHOTOMETRIC FILENAME : 6045 24 ID 35K F05.IES

POLAR GRAPH

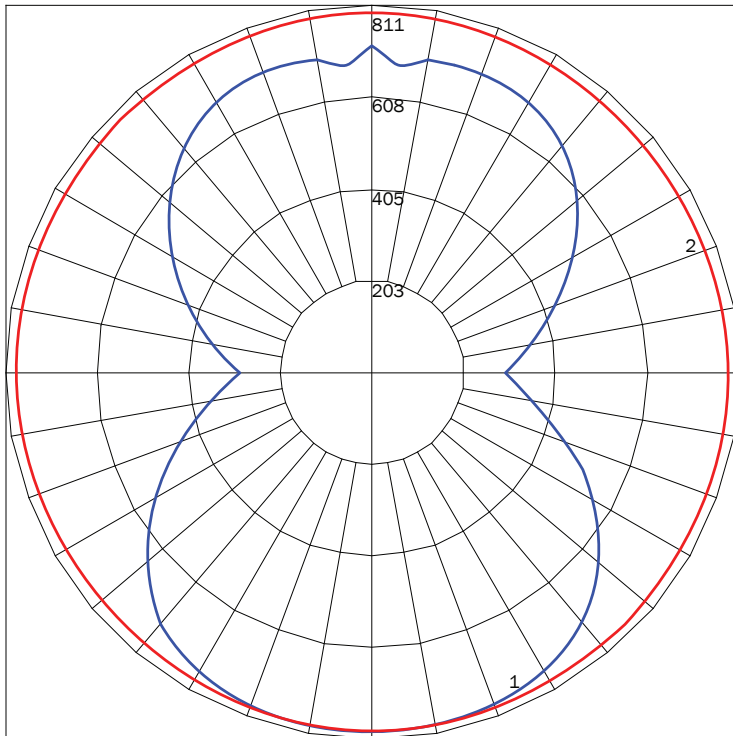

LUMINAIRE LUMENS 6715
TOTAL LUMINAIRE EFFICIENCY 81%
LUMINAIRE EFFICACY RATING 103
TOTAL LUMINAIRE WATTS 65

IES INDOOR REPORT

PHOTOMETRIC FILENAME : 6045 72 ID 35K F05.IES

POLAR GRAPH

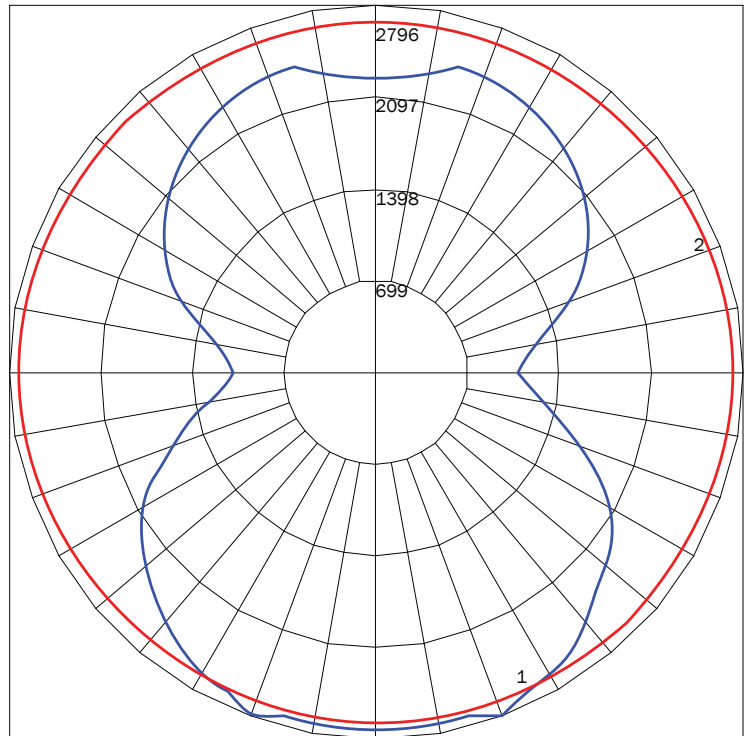

LUMINAIRE LUMENS 23680
TOTAL LUMINAIRE EFFICIENCY 79%
LUMINAIRE EFFICACY RATING 99
TOTAL LUMINAIRE WATTS 240

FINISHES



F04
MATTE
WHITE



F05
GLOSS
WHITE



F15
MATTE
BLACK



F16
GLOSS
BLACK



F09
PEWTER



F31
SILVER
METALLIC



F18
SATIN
ALUMINUM



F21
ARCH
BRONZE

PREMIUM FINISHES

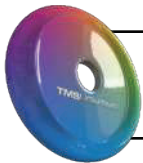

RAL
CUSTOM
(RAL #)



F40
BUBBLE
PINK



F10
FIRE
RED



F41
ELECTRIC
PURPLE



F08
MIDNIGHT
BLUE



F39
AQUA
BLUE



F13
FOREST
GREEN



F38
MEADOW
GREEN



F45
COPPER
METALLIC



F06
CLAY
BROWN



F11
CITRUS
ORANGE



F28
DARK
CHAMPAGNE



F22
HARVEST
GOLD



F14
SUNSHINE
YELLOW



F33
PYRITE
BRONZE



F07
ZEUS
BROWN



F32
BRONZE
METALLIC



F26
MELTED
COPPER



F25
MELTED
GOLD

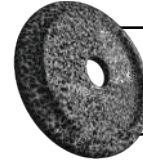

F24
MELTED
PLATINUM



F44
FAUX
COPPER



F43
FAUX
GOLD



F42
FAUX
CHROME

NOTE: DISPLAYED FINISHES DIFFER BETWEEN SCREENS AS WELL AS PRINTERS AND MAY NOT ACCURATELY DEPICT COLOR.