

PROJECT: _____

TYPE: _____

QUANTITY: _____



PN: CHW16

APPLICATION	<ul style="list-style-type: none">• WALL MOUNT• INDOOR OR OUTDOOR RATED
DIMENSION	<ul style="list-style-type: none">• 16" (41CM)
ILLUMINATION	<ul style="list-style-type: none">• DIRECT• LED 90CRI• INCANDESCENT MEDIUM BASE SOCKET• 753 - 1602 LUMENS
ELECTRICAL	<ul style="list-style-type: none">• 120V, 277V, AND 347V• 10kA SURGE SUPPRESSION STANDARD
DRIVER	<ul style="list-style-type: none">• WALL MOUNT (INTEGRAL)• REMOTE MOUNT (INDOOR OR OUTDOOR)
DIFFUSERS	<ul style="list-style-type: none">• CLEAR OR FROSTED, ELONGATED, GLASS GLOBE
MOUNTING	<ul style="list-style-type: none">• WALL, MOUNTED TO A 4"(10CM) J-BOX
CONSTRUCTION	<ul style="list-style-type: none">• ALUMINUM
FINISHES	<ul style="list-style-type: none">• AVAILABLE ANODIZED, BRUSHED, AND IN SEVERAL TMS POWDER COATED FINISHES• CUSTOM RAL FINISHES AVAILABLE
DIMMING	<ul style="list-style-type: none">• 0 - 10V STANDARD DIMMING
WEIGHT	<ul style="list-style-type: none">• 8.1 LBS MAXIMUM

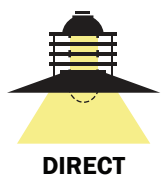



PROJECT: _____
 TYPE: _____
 QUANTITY: _____

CHW16

1 2 3 4 5 6 7 8 9 10

1.	I					O				
APPLICATION	INDOOR					OUTDOOR				
2.	ILLUMINATION									
	150IN					15LED				
LED (W)	150W					15W				
LUMENS	2375					1265				
3.	---		30K			35K			40K	
LED CCT	NONE		3000K			3500K			4000K	
4.	120			277			347			
VOLTAGE	120V			277V			347V			
5.	---		WM			N1			N4	
DRIVER	NONE		WALL MOUNT (INTEGRAL)			REMOTE INDOOR MOUNT (NEMA 1)			REMOTE OUTDOOR MOUNT (NEMA 4)	
6.	F04	F05	F15	F16	F09	F31	F18	F06	F07	F08
FINISH	MATTE WHITE	GLOSS WHITE	MATTE BLACK	GLOSS BLACK	PEWTER	SILVER METALLIC	SATIN ALUMINUM	CLAY BROWN	ZEUS BROWN	MIDNIGHT BLUE
	F10	F11	F13	F14	F21	F22	F24	F25	F26	F28
	FIRE RED	CITRUS ORANGE	FOREST GREEN	SUNSHINE YELLOW	ARCH. BRONZE	HARVEST GOLD	MELTED PLATINUM	MELTED GOLD	MELTED COPPER	DARK CAMPAGNE
	F32	F33	F38	F39	F40	F41	F42	F43	F44	F45
	BRONZE METALLIC	PYRITE BRONZE	MEADOW GREEN	AQUA BLUE	BUBBLE PINK	ELECTRIC PURPLE	FAUX CHROME	FAUX GOLD	FAUX COPPER	COPPER METALLIC
	RAL	BR	AN							
CUSTOM (SPECIFY RAL)	BRUSHED ALUMINUM	ANODIZED								
7.	---					DIML				
DIMMING	NONE					LED DIMMING (0 - 10V, CURRENT - SINKING)				
8.	---		EM			EMC		EMR		EMCR
EMERGENCY ¹	NONE		INTEGRAL			INTEGRAL COLD PACK		REMOTE		REMOTE COLD PACK
9.	G1					G2				
GLOBE/LENS	CLEAR, ELONGATED GLOBE					FROSTED GLOBE				
10.	---					W1V				
WIRE GUARD	NONE					W1V WIRE GUARD				

1. 10W AT 90 MINUTES. EMERGENCY OPTION IS ONLY AVAILABLE IN 120 - 277V SYSTEMS

NOTE: SOME OPTIONS MAY NOT BE COMPATIBLE WITH OTHERS. ALL SPECIFICATIONS ARE SUBJECT TO CHANGE WITHOUT NOTICE. CONTACT TMS LIGHTING FOR UPDATED SPECIFICATIONS.

CHW16

PROFILE

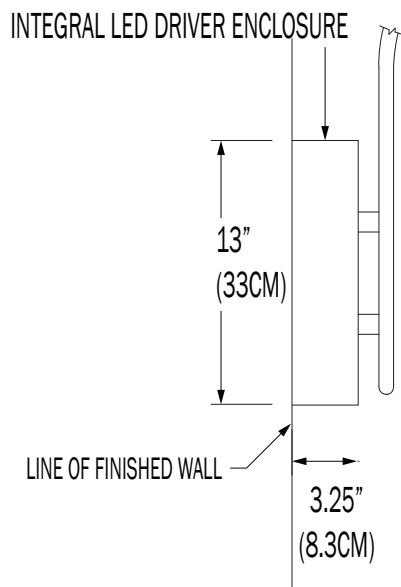
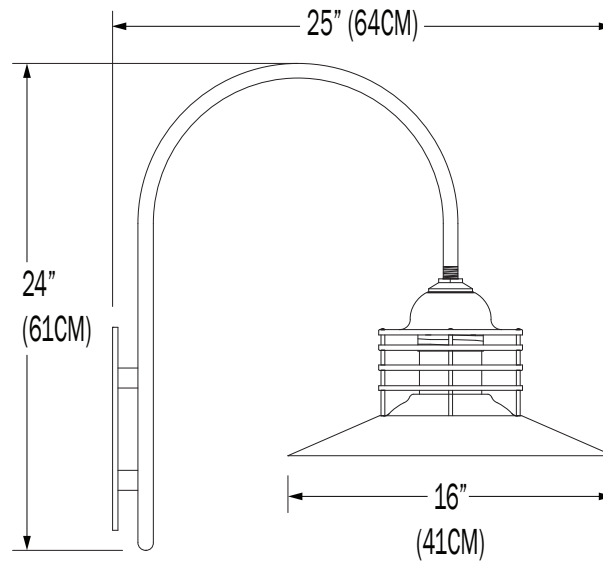

CUSTOM

NOTE: THIS FIXTURE CAN BE CUSTOMIZE. DIMENSION, LAMP TYPES, ENCLOSURE, AND COLOR CAN BE MODIFIED TO SUIT YOUR LIGHTING AND ARCHITECTURAL REQUIREMENTS. CONTACT YOUR LOCAL REPRESENTATIVE FOR MORE DETAILS: <https://tmslighting.com/sales-agents.html>

DIRECT

PN	ILLUMINATION	LUMENS	WATTAGE
CHW16	15LED	2025	15
	150IN	2657	150

IES INDOOR REPORT

PHOTOMETRIC FILENAME : CHW16 15LED G3.IES

POLAR GRAPH

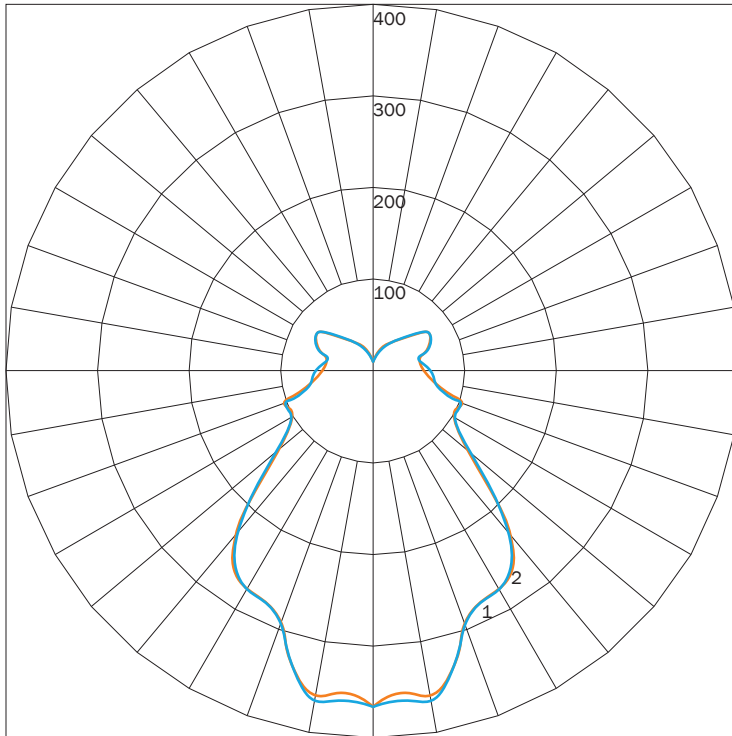

MAXIMUM CANDELA = 384.62 LOCATED AT HORIZONTAL ANGLE = 15, VERTICAL ANGLE = 5
 # 1 - VERTICAL PLANE THROUGH HORIZONTAL ANGLES (90 - 270)
 # 2 - VERTICAL PLANE THROUGH HORIZONTAL ANGLES (0 - 180)

LUMINAIRE LUMENS 1265
TOTAL LUMINAIRE EFFICIENCY NA
LUMINAIRE EFFICACY RATING 74
TOTAL LUMINAIRE WATTS 17

IES INDOOR REPORT

PHOTOMETRIC FILENAME : CHW16 150IN G3.IES

POLAR GRAPH

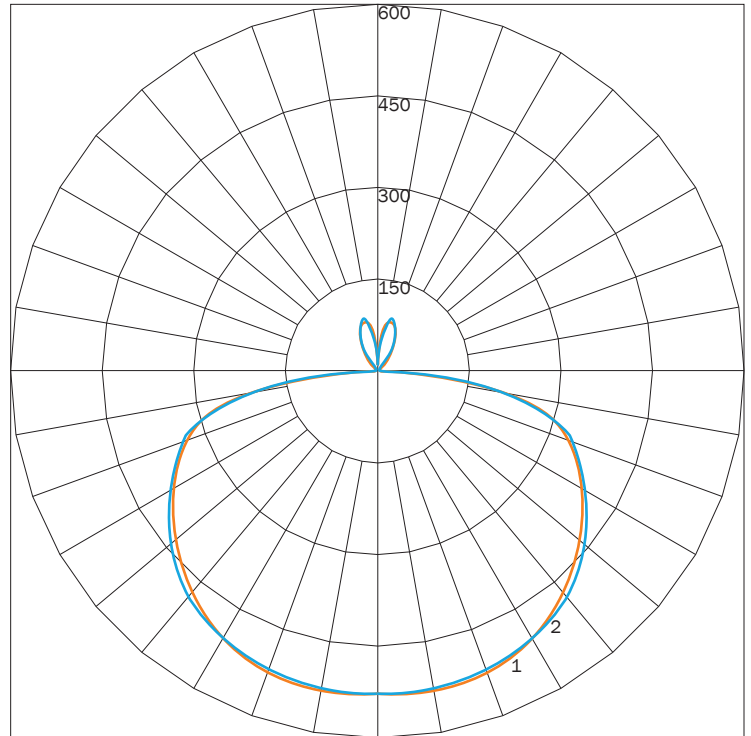

MAXIMUM CANDELA = 576.011 LOCATED AT HORIZONTAL ANGLE = 67.5, VERTICAL ANGLE = 5
 # 1 - VERTICAL PLANE THROUGH HORIZONTAL ANGLES (90 - 270)
 # 2 - VERTICAL PLANE THROUGH HORIZONTAL ANGLES (0 - 180)

LUMINAIRE LUMENS 2375
TOTAL LUMINAIRE EFFICIENCY 89%
LUMINAIRE EFFICACY RATING 16
TOTAL LUMINAIRE WATTS 150

FINISHES



F04
MATTE
WHITE



F05
GLOSS
WHITE



F15
MATTE
BLACK



F16
GLOSS
BLACK



F09
PEWTER



F31¹
SILVER
METALLIC



F18
SATIN
ALUMINUM

PREMIUM FINISHES



F40
BUBBLE
PINK



F10
FIRE
RED



F41
ELECTRIC
PURPLE



F08
MIDNIGHT
BLUE



F39
AQUA
BLUE



F13
FOREST
GREEN



F38
MEADOW
GREEN



F45
COPPER
METALLIC



F06
CLAY
BROWN



F11
CITRUS
ORANGE



F28¹
DARK
CHAMPAGNE



F22¹
HARVEST
GOLD



F14
SUNSHINE
YELLOW



F33¹
PYRITE
BRONZE



F07
ZEUS
BROWN



F21
ARCH
BRONZE



F32¹
BRONZE
METALLIC



F26¹
MELTED
COPPER



F25¹
MELTED
GOLD

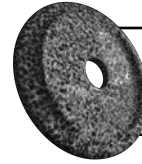

F24¹
MELTED
PLATINUM



F44¹
FAUX
COPPER

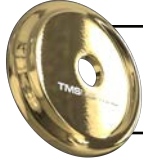

F43¹
FAUX
GOLD



F42¹
FAUX
CHROME

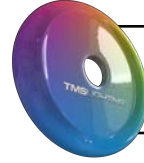

RAL
CUSTOM
(RAL #)

PREMIUM MATERIALS



BR^{1 2}
BRUSHED
ALUMINUM



AN^{1 2}
ANODIZED

1: FINISHES IS APPLIED TO THE INTERIOR AND EXTERIOR OF THE FIXTURE.

2: MATERIALS ARE CONSISTENT (INTERIOR & EXTERIOR). STEMS AND CANOPIES WILL BE F16 GLOSS BLACK.

NOTE: ALL FINISHES NOT MARKED WITH NOTATION (1) ARE APPLIED TO THE EXTERIOR ONLY. THE INTERIOR WILL BE F05 GLOSS WHITE. MATTE FINISHES AVAILABLE. CONSULT FACTORY.

FINISHES ARE SUBJECT TO AVAILABILITY AND MAY NOT BE APPLICABLE TO ALL FIXTURES OR FOR QUICKSHIP.

DISPLAYED FINISHES DIFFER BETWEEN SCREENS AS WELL AS PRINTERS AND MAY NOT ACCURATELY DEPICT COLOR.

ALL FINISHES MAY NOT BE AVAILABLE FOR ALL PRODUCTS. CONSULT THE PRODUCT SPECIFICATIONS FOR MORE INFORMATION.